



MOMO
UPHOLSTERED PANELS

INTRODUCTION

DESIGNERS 07

SOFORM PANELS 08

FABRICS 13

MOMO PANELS

PERFECT RECTANGULAR 14

COSY ELEGANCE 20

GAME OF SQUARES 32

GEOMETRIC PLAY 38

IN CIRCLES 44

SETS

GREY AND PINK 54

GREY AND MUSTARD 66

GREEN AND GREY 80

NAVY BLUE AND GREY 94

SET IDEAS 108

SELF-ASSEMBLY 110





FREEDOM BEGINS
at home

At MOMO, we believe that true freedom begins at home and rather than a defined interior style, what really matters are the needs and lifestyles of your family members. That's why it is our goal to inspire, advise and deliver complex interior solutions -matching collections of furniture, doors, floors and decorative walls.





DESIGNERS



Every day we join forces with talented creators. Thanks to their passion, upholstered decorations not only please the eyes, but fulfil their practical role.

The panel collection includes several geometric forms. They have been made with carefully selected fabrics to diversify interiors and offer great freedom of arrangement. Upholstered headrests and recesses help to create a friendly atmosphere, and ready-made sets invite you to play with wall decorations.

MOMO PANELS. COMFY WALL

As soft as a cushion, soft to touch just like your favourite armchair and compellingly beautiful. This description fits every wall decorated with MOMO panels. Dozens of variants and only one goal - to make you feel really comfortable in your home. Dedicated accessories will help to change the decoration into an original hanger or an inspiration board. A subtle accent or maybe the main part of a cosy arrangement? Choose your favourite shape and give your wall more meaning.

ONE PRODUCT, MANY WORLDS



MOMO upholstered panels delight with their multiple applications. They are great as the decoration of the entire wall or when used to cover part of the wall only. They work well as a headboard or in a recesses area. Our soft to touch panels can be used anywhere you want, in the living room, in the bedroom, child's room or the hall. The wide range of shapes and sizes makes it possible to create any configuration. Play with your arrangements, combine the square with a rectangular or geometrical shape with circles. Enjoy the makeover of your favourite space.



FABRICS

TON FABRIC
NAVY BLUE VELVET SHINY



TON FABRIC
BLACK VELVET MATT

TON FABRIC
MUSTARD VELVET SHINY



BURANO FABRIC
LIGHT PINK VELVET MATT

CHOPPER FABRIC
PINK MELANGE

SCOT FABRIC
GREY VELVET MATT



ANGUS FABRIC
BEIGE TWEED

CLARK FABRIC
GREY WOOL

PETRUS FABRIC
GRAPHITE TWEED



MANGO FABRIC
GREY MELANGE

GEORGE FABRIC
BOTTLE GREEN
VELVET SHINY



MANGO FABRIC
GREEN MELANGE



A diagonal weave, stain-resistant knitted fabric with a fine structure, smooth velour with a velvet sheen or robust fabric with natural wool - there is no coincidence in the selection of fabrics. MOMO upholstered panels captivate with their interesting looks and are comfortable to use. You can choose from 9 different fabrics in 12 colours. The upholstery may be hydrophobic, fire or abrasion resistant. Choose a solution that will fulfill your design fantasies.



PANEL REGULAR 1, GREY WOOL

PERFECT RECTANGLE



The panels have universal shapes and colours so they can easily be used to cover large wall areas, for instance in the hall. A grey composition made with grey rectangles creates a soft to touch backrest and ensures everyday comfort. Add some hooks to organise the space for coats and jackets of your nearest and dearest. Feel more comfortable and impress your guests at the very entrance.

REGULAR 1

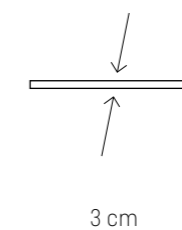
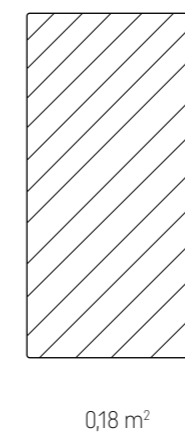
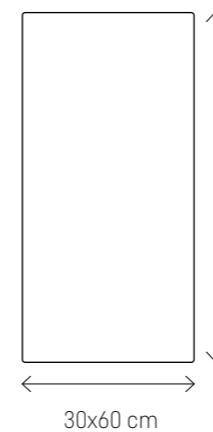

WIDE RANGE OF COLOURS



LIGHTNESS



EASY INSTALLATION



MADE IN POLAND

MOMO COLOURS



Beige Tweed



Graphite Tweed



Grey Wool



Pink Melange



Green Melange



Grey Melange



Light Pink
Velvet Matt



Grey Velvet
Matt



Black Velvet
Matt



Mustard Velvet
Shiny



Bottle Green
Velvet Shiny



Navy Blue
Velvet Shiny

Grey Wool fits nicely in halls, and Navy Blue Velvet Shiny – in your study. There is a choice from among 12 different colours.

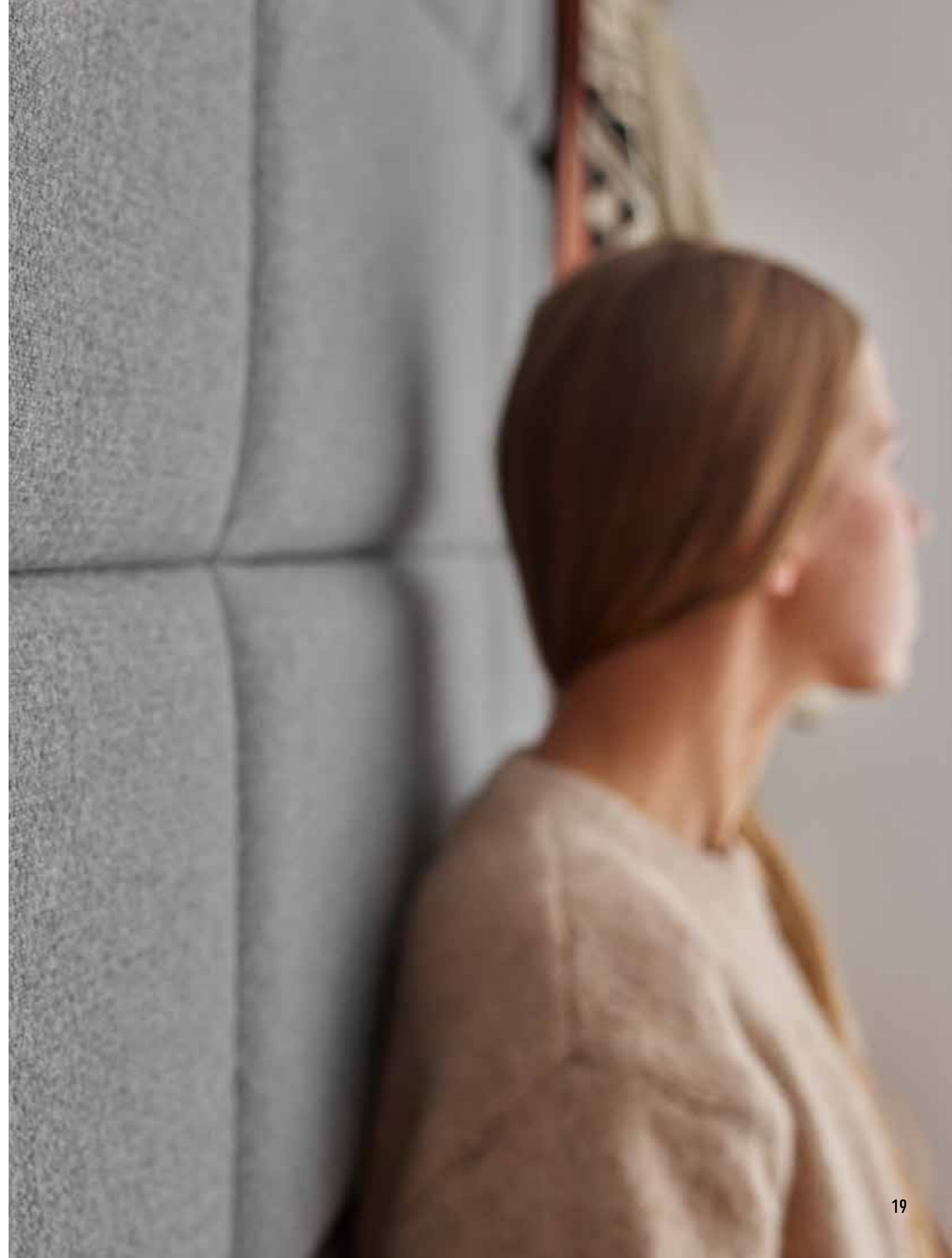





PANEL REGULAR 2, BLACK VELVET MATT

COSY ELEGANCE

Elegance can take on many different faces and feels great in the company of cosiness. The slightly elongated shape of the panels offers great freedom of arrangement. You can create a unique headrest for your bed to feel comfortable during your evening reading session, while giving the impression of unusual warmth. You can easily choose the right colour to create a harmonious duet with your furniture. Here every arrangement is always a success.

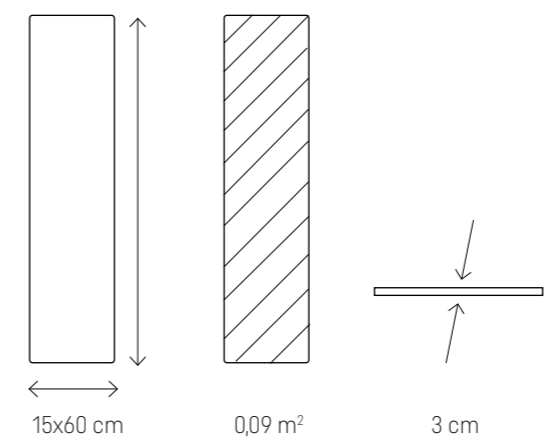
REGULAR 2



-  WIDE RANGE OF COLOURS
-  LIGHTNESS
-  EASY INSTALLATION
-  MADE IN POLAND

MOMO COLOURS



Beige Tweed



Graphite Tweed



Grey Wool



Pink Melange



Green Melange



Grey Melange



Light Pink
Velvet Matt



Grey Velvet
Matt



Black Velvet
Matt



Mustard Velvet
Shiny



Bottle Green
Velvet Shiny



Navy Blue
Velvet Shiny

Green Melange works well in a boy's room, and Grey Velvet Matt will perfectly furnish the living room. There are many options available with which you can distinguish any space in your home.





MOMO EXAMPLE SETS

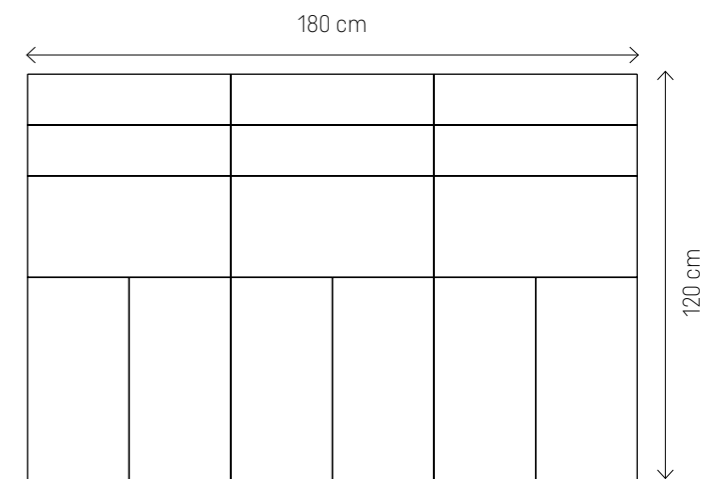
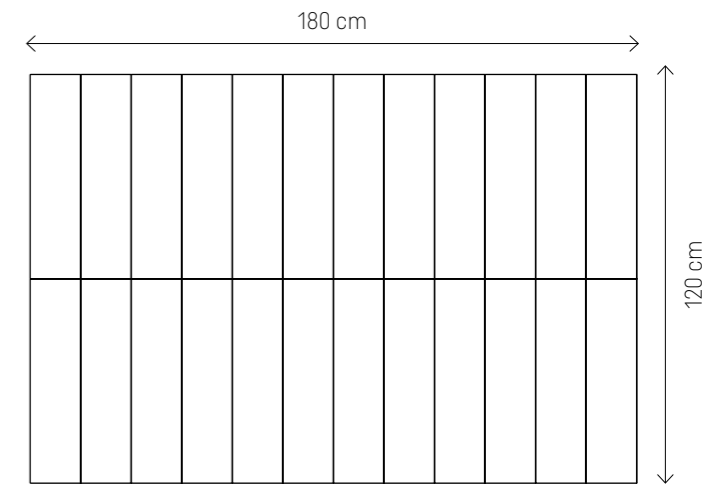

The panels can be combined in many ways. Rectangles offer the most flexibility and work well together both vertically and horizontally. Arrange them in a parallel or perpendicular manner and combine shades and fabrics. Discover the endless possibilities offered by Soform panels.

ATTENTION!

Upholstered panels are a solution that offer both decorative and practical value. Aesthetically finished, they provide additional acoustic insulation, insulate the wall and cover small irregularities on its surface.





PANEL REGULAR 2, GREEN MELANGE
 PANEL REGULAR 2, BOTTLE GREEN VELVET SHINY

MOMO EXAMPLE SETS

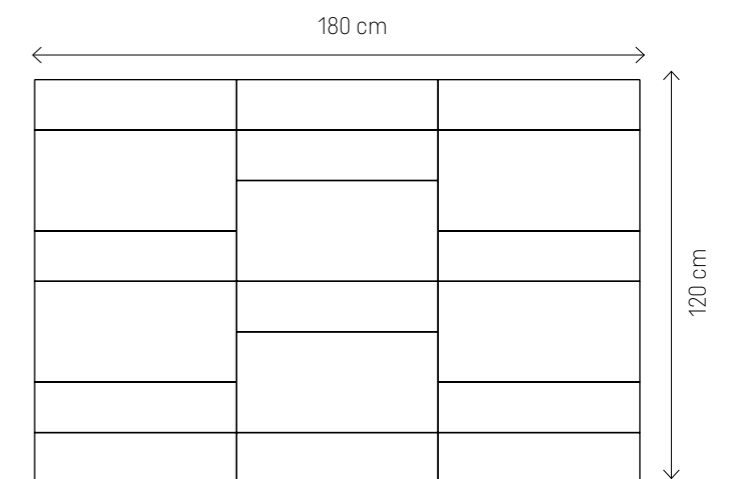
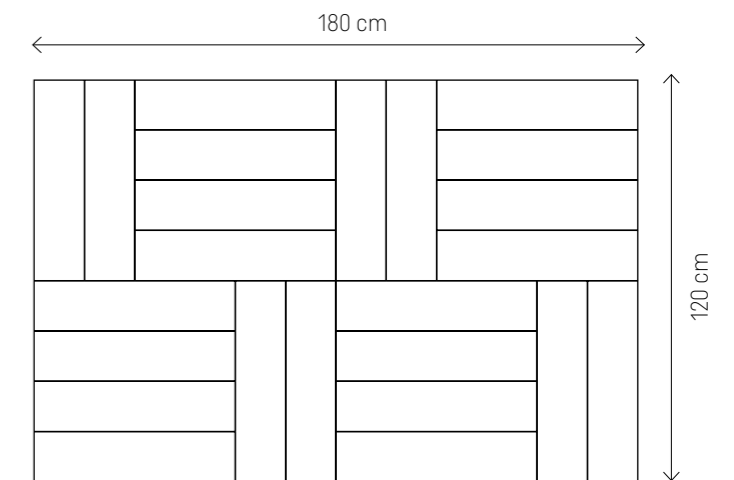

By combining MOMO upholstered panels you can create functional compositions. The available shapes, fabrics and shades were selected by MOMO designers to create a perfect harmony.



PANEL REGULAR 3, GREY WOOL
PANEL REGULAR 3, BEIGE TWEED
REGULAR 2, GREY WOOL

GAME OF SQUARES

When you recall your childhood playground games and being inspired by this memory, assemble a new composition. Large square panels are a great addition to your study or study corner. Mounted above the desk they will serve as a pin board for important notes and inspirations, yet making your interior feel a bit more cosy. It is extremely easy to combine them with other panels, for example Regular 1 and Regular 2, creating a composition perfectly suited to your specific needs.

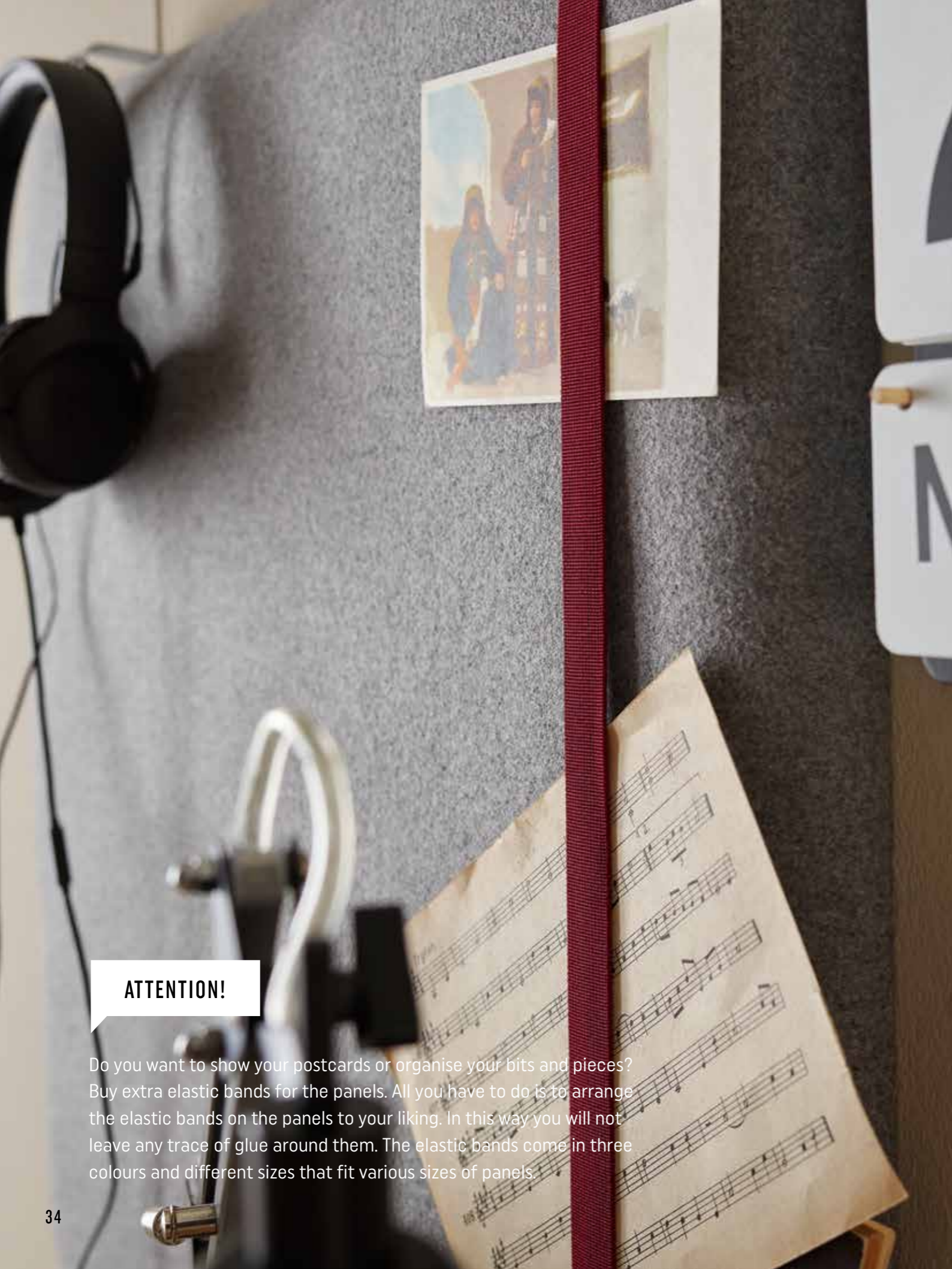

ATTENTION!

Do you want to show your postcards or organise your bits and pieces? Buy extra elastic bands for the panels. All you have to do is to arrange the elastic bands on the panels to your liking. In this way you will not leave any trace of glue around them. The elastic bands come in three colours and different sizes that fit various sizes of panels.

REGULAR 3

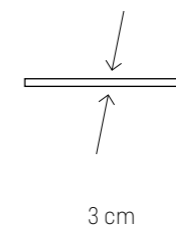
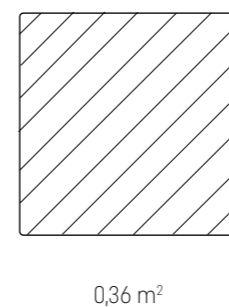
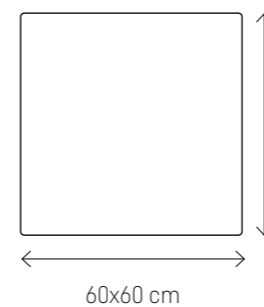
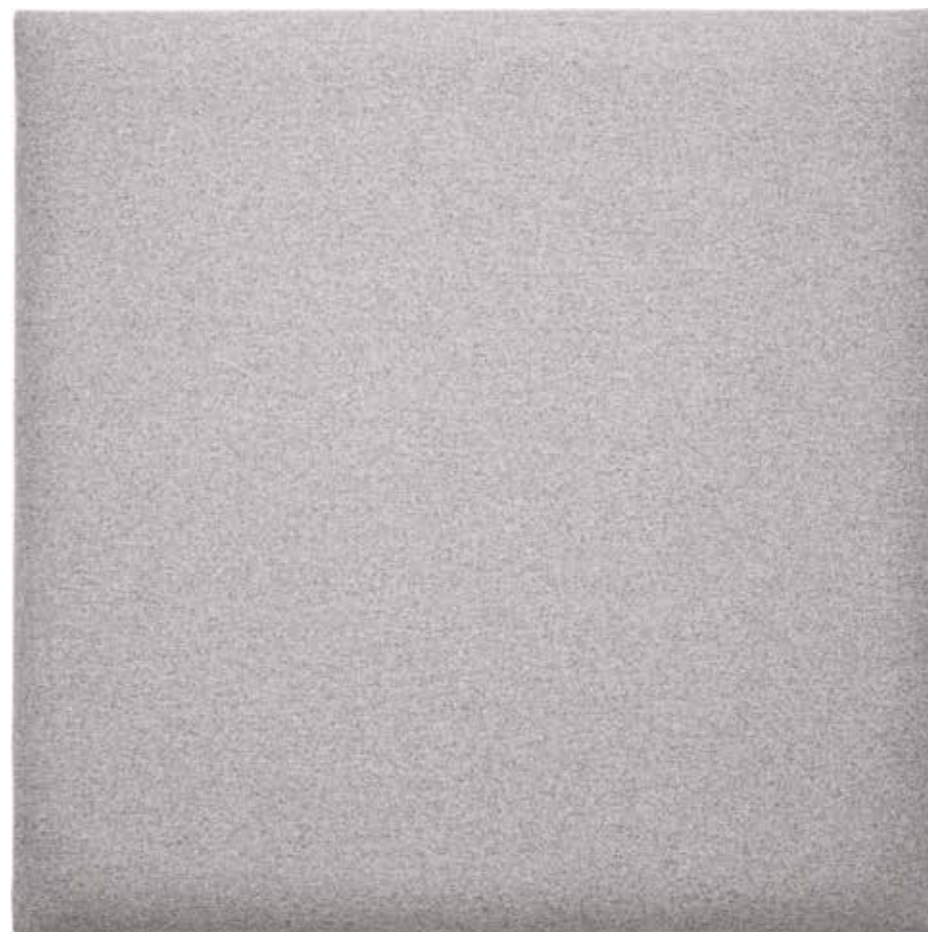

MOMO COLOURS



Beige Tweed



Graphite Tweed



Grey Wool

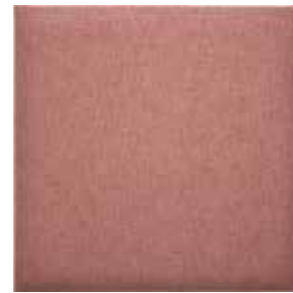

Pink Melange



Green Melange



Grey Melange



Light Pink
Velvet Matt



Grey Velvet
Matt



Black Velvet
Matt



Mustard Velvet
Shiny



Bottle Green
Velvet Shiny



Navy Blue
Velvet Shiny

Graphite Tweed in the dining room, or maybe Mustard Velvet Shiny in the living room? Choose the best colour for your home.





PANEL GEO, PINK MELANGE

GEOMETRIC PLAY

Enrich your interior with a soft backrest and a unique wall decoration in one. Slanted panels will appeal to all fans of unusual solutions. They can be used to arrange a headboard in your bedroom - such irregular composition will distinguish this personal space among others.

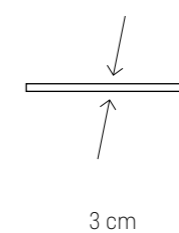
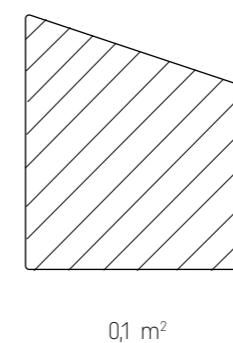
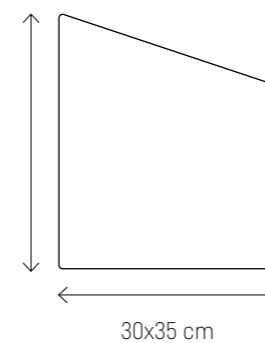

MOMO COLOURS



Beige Tweed



Graphite Tweed



Grey Wool



Pink Melange



Green Melange



Grey Melange



Light Pink
Velvet Matt



Grey Velvet
Matt



Black Velvet
Matt



Mustard Velvet
Shiny



Bottle Green
Velvet Shiny



Navy Blue
Velvet Shiny

Beige Tweed in a subdued hallway or Velvet Shiny Bottle Green in a tasteful guest bedroom? Choose a colour that will give the right character to your space.





PANEL OVAL 1, LIGHT PINK VELVET MATT

IN CIRCLES

Do round shapes appeal more to you than edgy geometry? You can opt for panels with rounded edges, available in three variants. They will be great as decorative wall protection in your child's room, a little fence in the drawing corner or quilted panels to which your little one will be able to attach their favourite pictures. You can create your own cosy composition.



OVAL 1

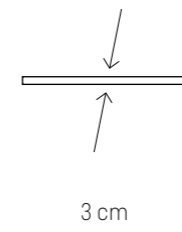
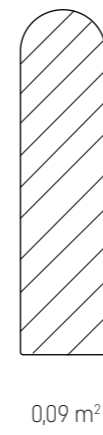

WIDE RANGE
OF COLOURS



LIGHTNESS



EASY
INSTALLATION



MADE IN
POLAND

MOMO COLOURS



Beige Tweed



Graphite Tweed



Grey Wool



Pink Melange



Green Melange



Grey Melange



Light Pink
Velvet Matt



Grey Velvet
Matt



Black Velvet
Matt



Mustard Velvet
Shiny



Bottle Green
Velvet Shiny



Navy Blue
Velvet Shiny

Pink Melange works well in a feminine space, and Black Velvet Matt might complete an elegant bedroom.



OVAL 2



Beige Tweed

Graphite Tweed

Grey Wool

Pink Melange



Green Melange

Grey Melange

Light Pink
Velvet Matt

Grey Velvet
Matt



Black Velvet
Matt

Mustard Velvet
Shiny

Bottle Green
Velvet Shiny

Navy Blue
Velvet Shiny

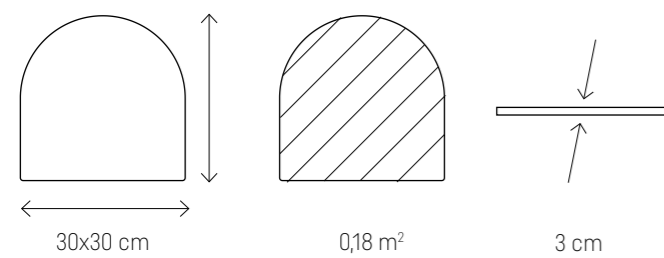

OVAL 3



Beige Tweed

Graphite Tweed

Grey Wool

Pink Melange



Green Melange

Grey Melange

Light Pink
Velvet Matt

Grey Velvet
Matt



Black Velvet
Matt

Mustard Velvet
Shiny

Bottle Green
Velvet Shiny

Navy Blue
Velvet Shiny

Grey Melange in the bedroom,
or Light Pink Velvet Matt in a girl's room?
You decide about the looks of your walls.





MOMO SETS. JUST CHOOSE

Too much choice? Maybe you prefer to use one of the ready-made sets offered by MOMO designers. The available sets come in 5 sizes and 4 carefully chosen colour pallets. Well thought-through composition made with our panels may become a cosy addition to the living room, bedroom or the hall. Examine all the options and make your interior unique with simple and quick solution!



**LARGE MOMO SET OVAL
GREY AND PINK**



ELEMENTS

- OVAL 2 | Grey Velvet Matt 2 pcs.
- REGULAR 2 | Beige Tweed 1 pc.
- REGULAR 1 | Pink Melange 1 pc.
- REGULAR 3 | Grey Wool 1 pc.
- OVAL 1 | Light Pink Velvet Matt 4 pcs.

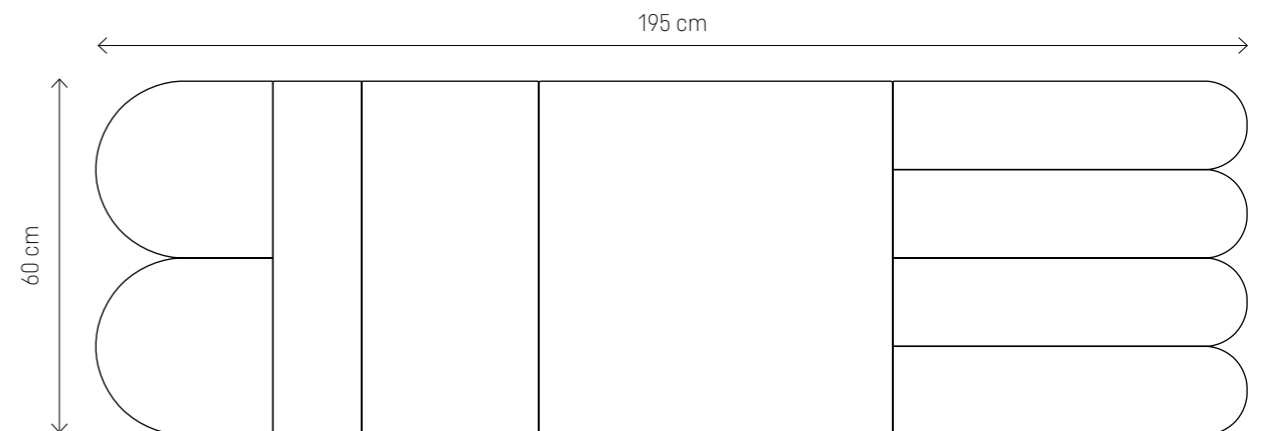

**LARGE MOMO SET REGULAR
GREY AND PINK**



ELEMENTS

- REGULAR 1 | Grey Wool 1 pc.
- REGULAR 2 | Pink Melange 1 pc.
- REGULAR 3 | Light Pink Velvet Matt 1 pc.
- REGULAR 1 | Beige Tweed 1 pc.
- REGULAR 2 | Grey Wool 1 pc.
- REGULAR 1 | Pink Melange 1 pc.

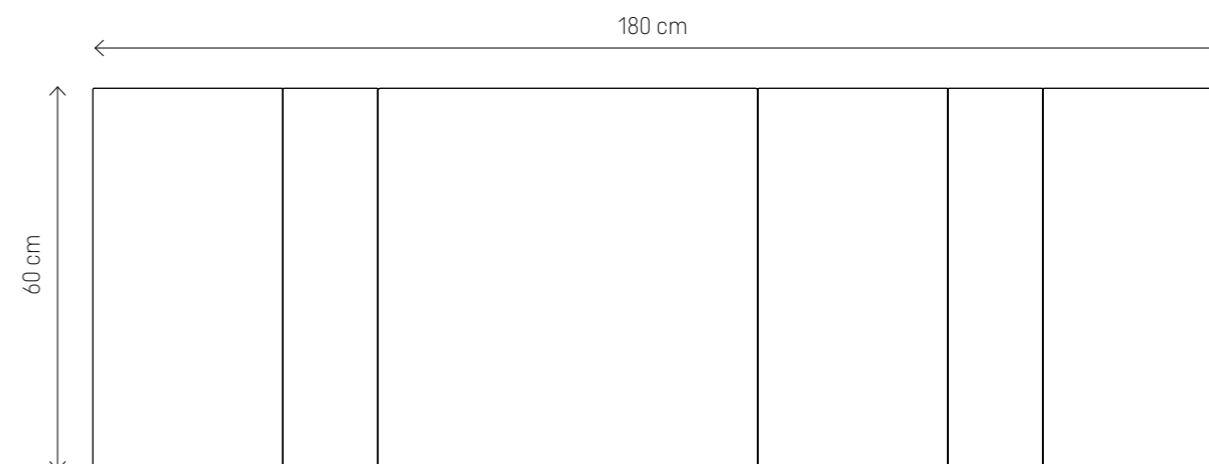



**MEDIUM-SIZE MOMO SET
GREY AND PINK**

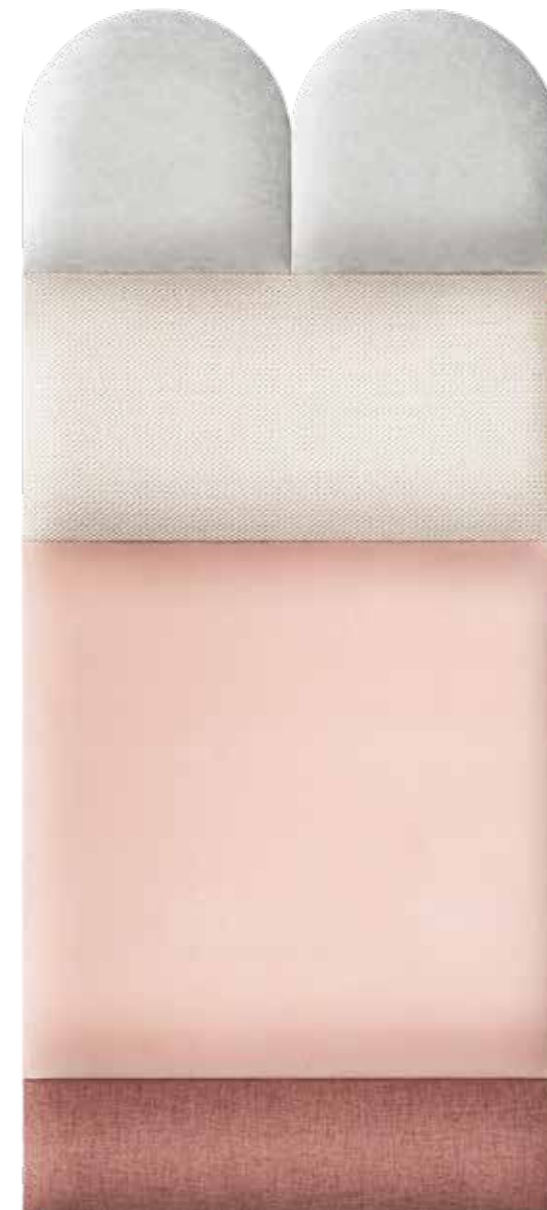

ELEMENTS

- OVAL 2 | Grey Velvet Matt 2 pcs.
- REGULAR 1 | Beige Tweed 1 pc.
- REGULAR 3 | Light Pink Velvet Matt 1 pc.
- REGULAR 2 | Pink Melange 1 pc.

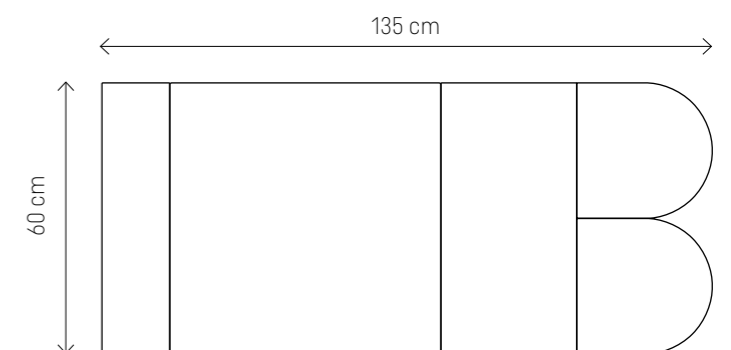



The sets can be mounted on the wall horizontally or vertically.
Choose the best option for yourself.

SMALL MOMO SET
GREY AND PINK

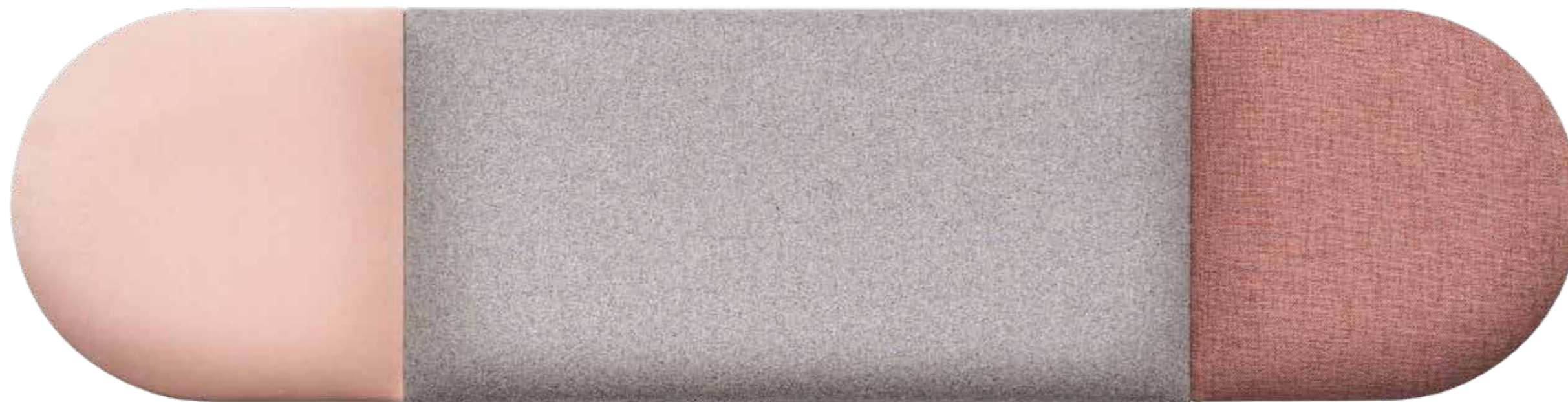

ELEMENTS

- OVAL 2 | Light Pink Velvet Matt 1 pc.
- REGULAR 2 | Grey Wool 1 pc.
- OVAL 2 | Pink Melange 1 pc.

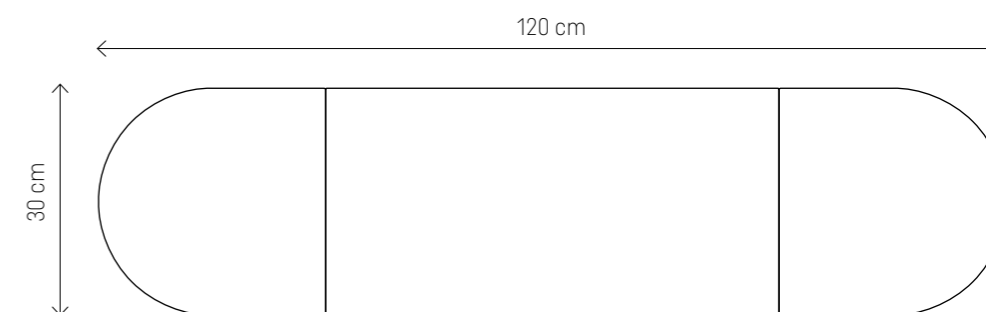



ATTENTION!

Notes, photos or souvenirs can be attached to the panels with pins or drawing pins. It is quick and easy to have all your important belongings anywhere you want.

**MINI MOMO SET
GREY AND PINK**

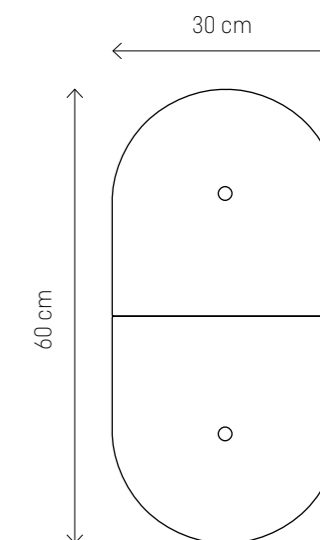

ELEMENTS

- OVAL 3 | Light Pink Velvet Matt 1 pc.
- OVAL 3 | Grey Wool 1 pc.



The composition attracts attention with its choice of colours - subdued grey and black are a great complement to the saturated mustard yellow.

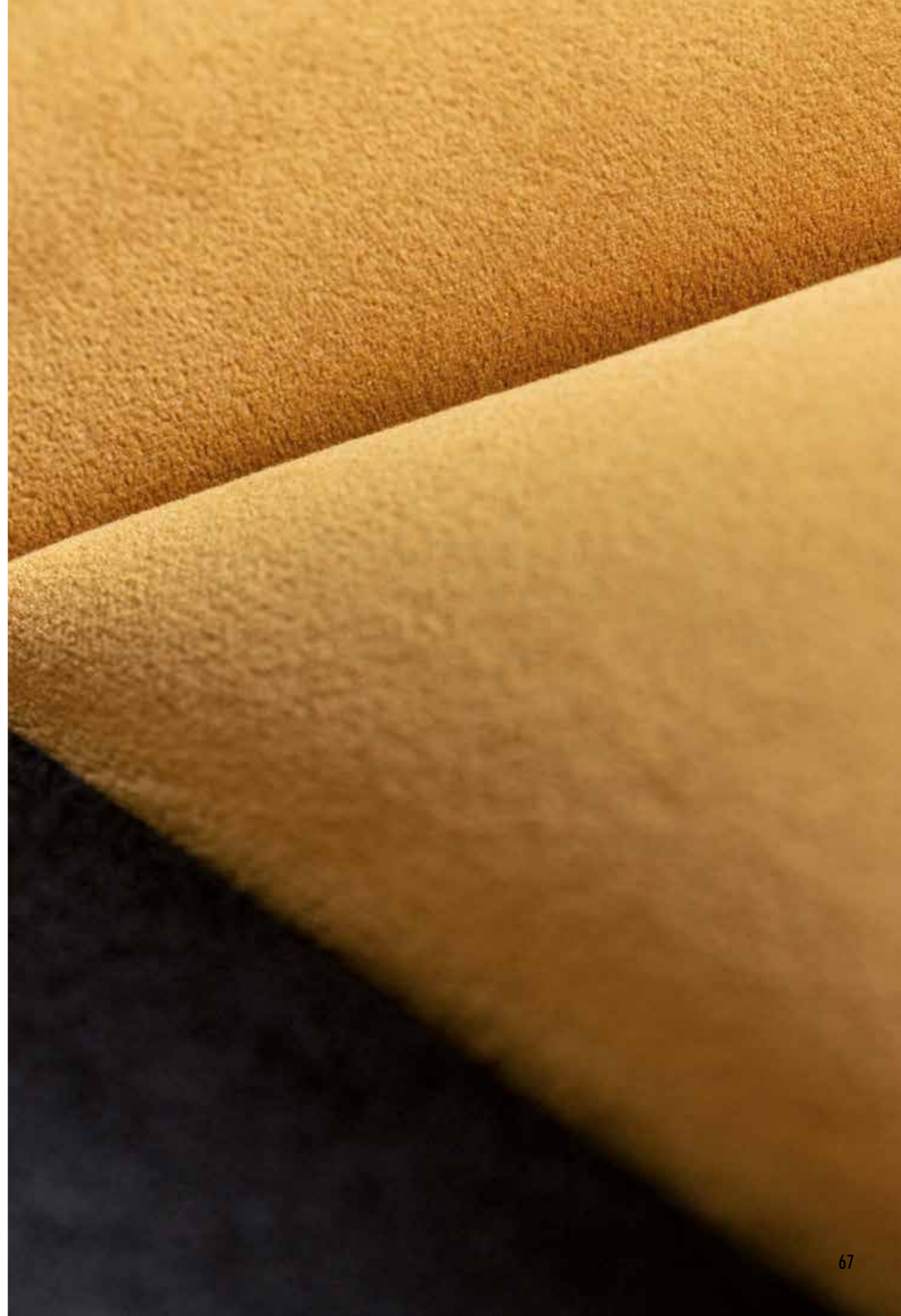

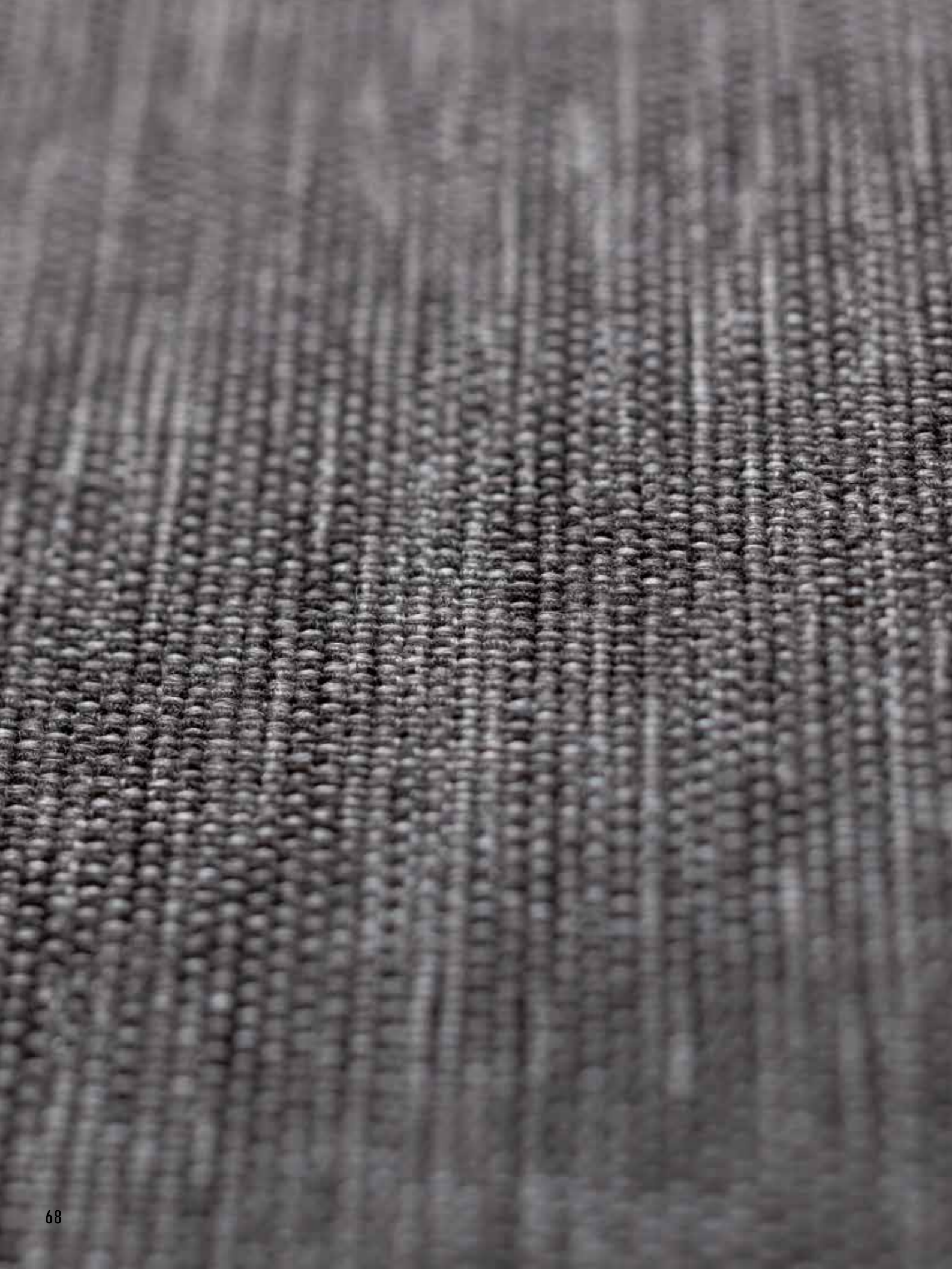

MEDIUM-SIZE MOMO SET GREY AND MUSTARD



ELEMENTS

- REGULAR 2 | Black Velvet Matt 1 pc.
- REGULAR 3 | Grey Melange 1 pc.
- REGULAR 1 | Beige Tweed 1 pc.
- OVAL 3 | Mustard Velvet Shiny 2 pc.

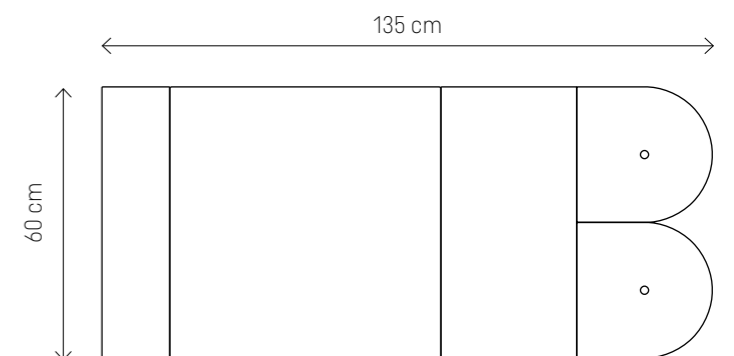

LARGE MOMO SET OVAL
GREY AND MUSTARD

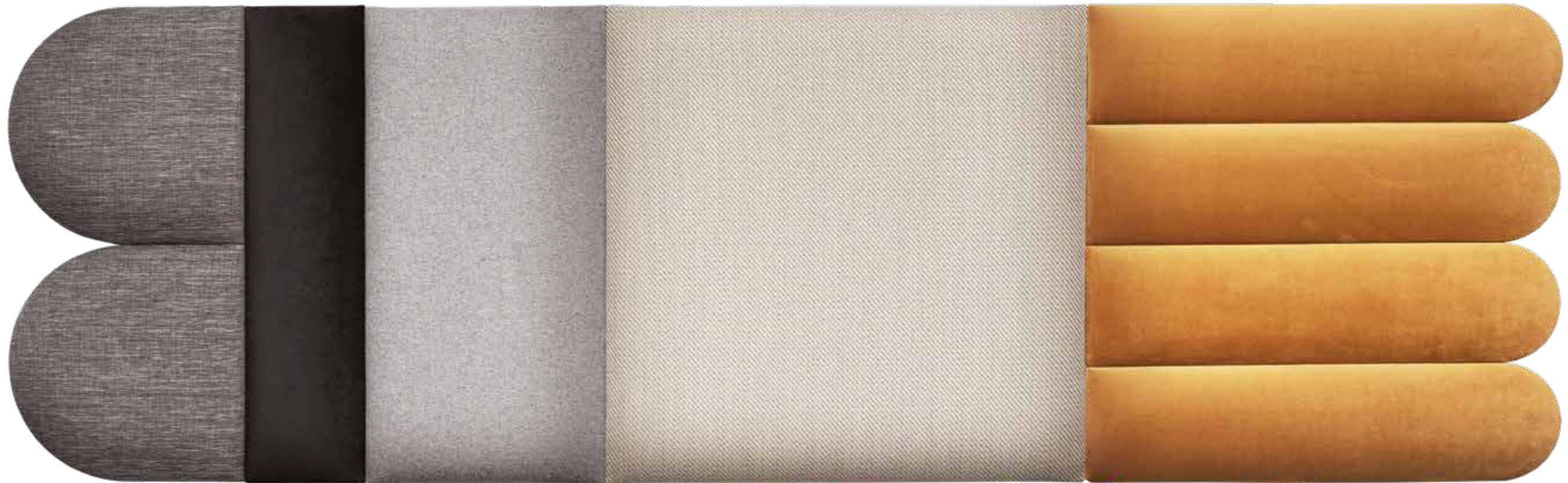

ELEMENTS

- OVAL 2 | Grey Melange 2 pcs.
- REGULAR 2 | Black Velvet Matt 1 pc.
- REGULAR 1 | Grey Wool 1 pc.
- REGULAR 3 | Beige Tweed 1 pc.
- OVAL 1 | Mustard Velvet Shiny 4 pcs.

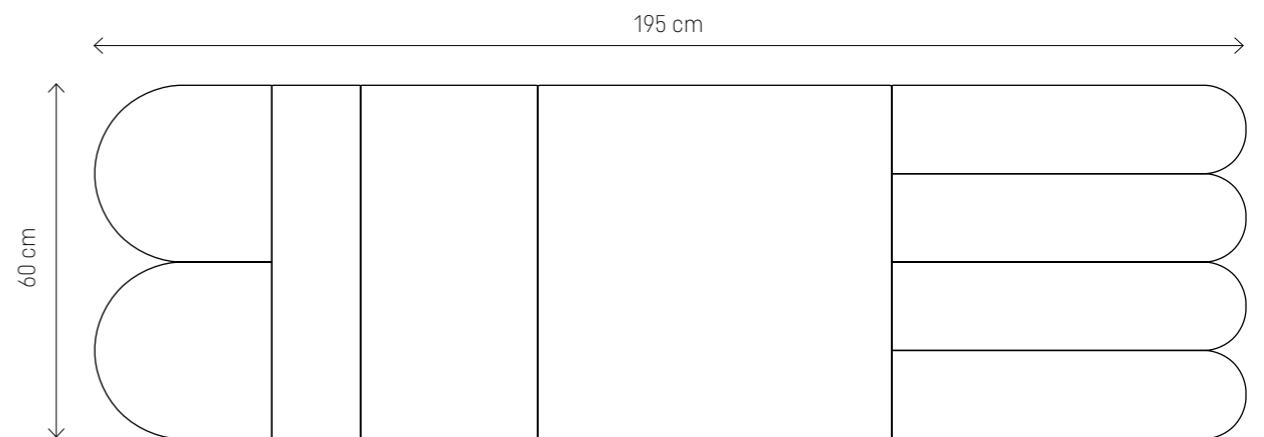

**LARGE MOMO SET REGULAR
GREY AND MUSTARD**



ELEMENTS

- REGULAR 1 | Mustard Velvet Shiny 1 pc.
- REGULAR 2 | Black Velvet Matt 1 pc.
- REGULAR 3 | Grey Melange 1 pc.
- REGULAR 1 | Beige Tweed 1 pc.
- REGULAR 2 | Black Velvet Matt 1 pc.
- REGULAR 1 | Grey Wool 1 pc.

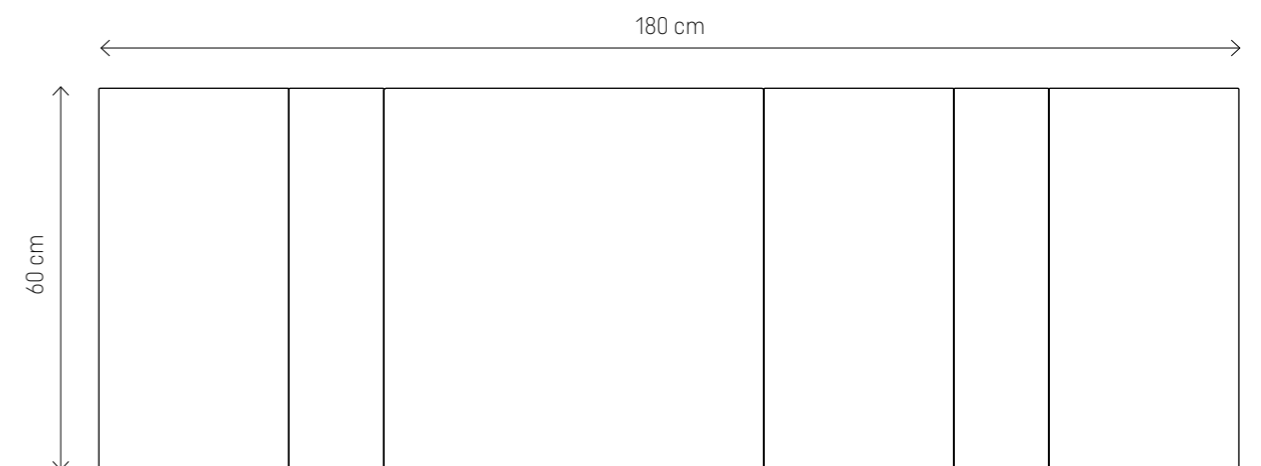



**SMALL MOMO SET
GREY AND MUSTARD**

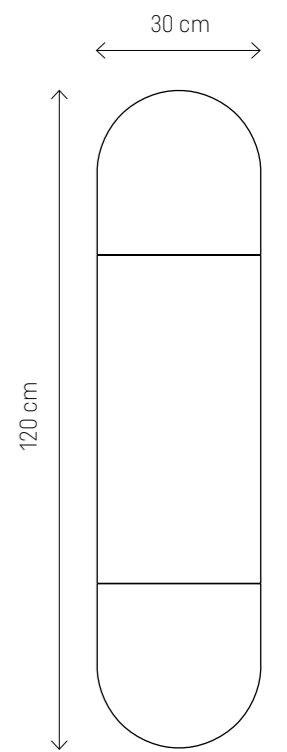

ELEMENTY

- OVAL 2 | Black Velvet Matt 1 pc.
- REGULAR 2 | Mustard Velvet Shiny 1 pc.
- OVAL 2 | Beige Tweed 1 pc.

MINI MOMO SET
GREY AND MUSTARD

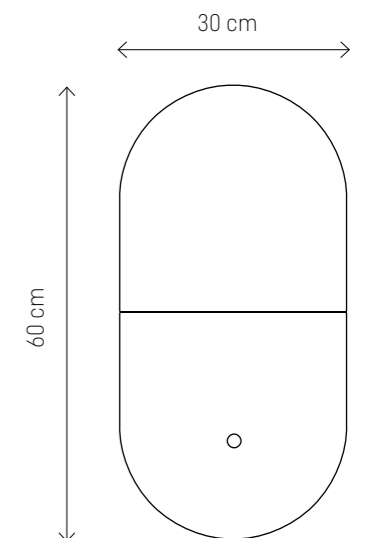
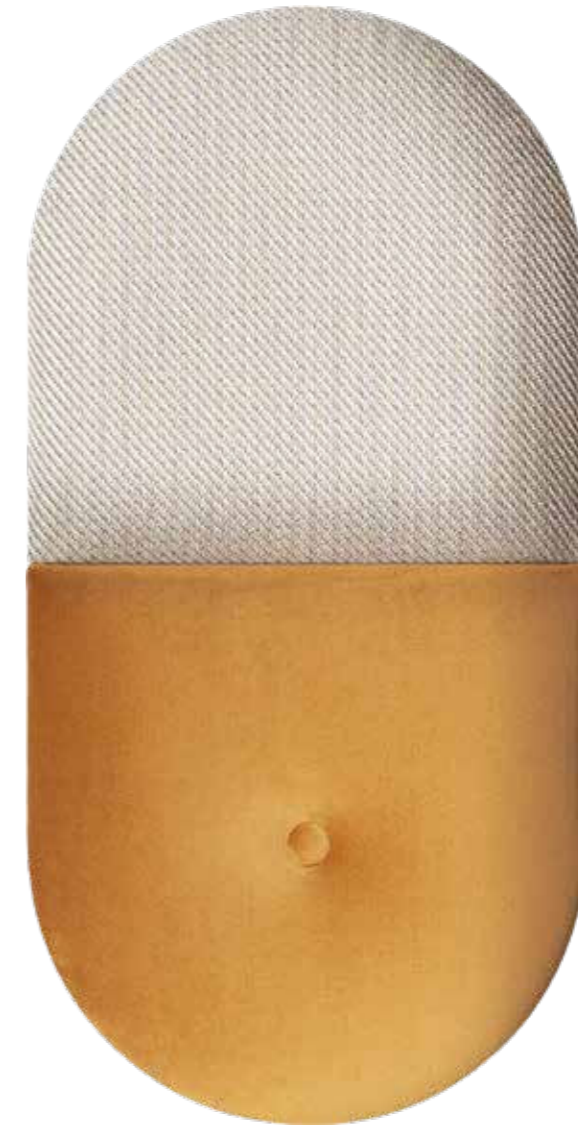

ELEMENTS

- OVAL 2 | Beige Tweed 1 pc.
- OVAL 3 | Mustard Velvet Shiny 1 pc.





ATTENTION!

The panels can be equipped with hooks to hang your handbag or a charger. A metal hook should be placed between the chosen panels before they are attached to the wall.

**MINI MOMO SET
GREEN AND GREY**

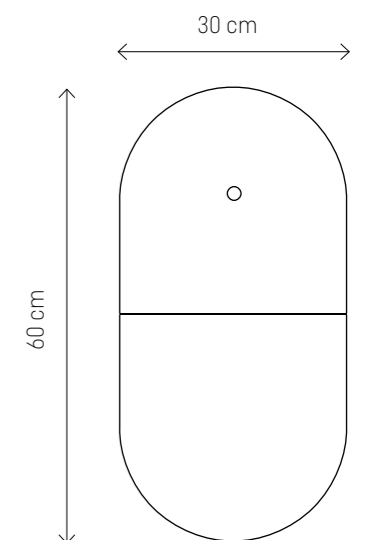
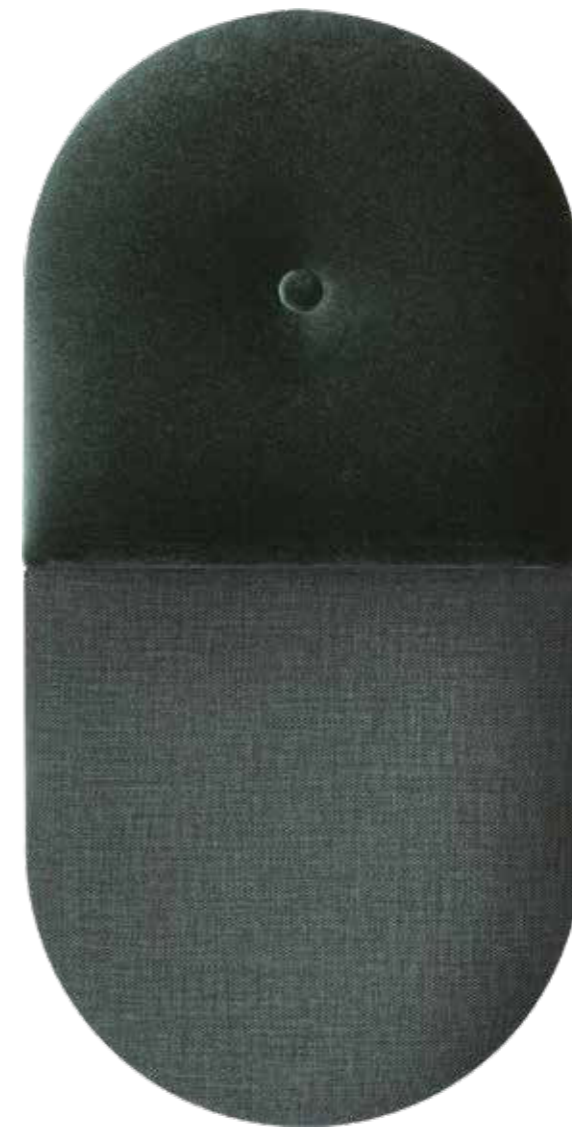

ELEMENTS

- OVAL 3 | Bottle Green Velvet Shiny 1 pc.
- OVAL 2 | Green Melange 1 pc.

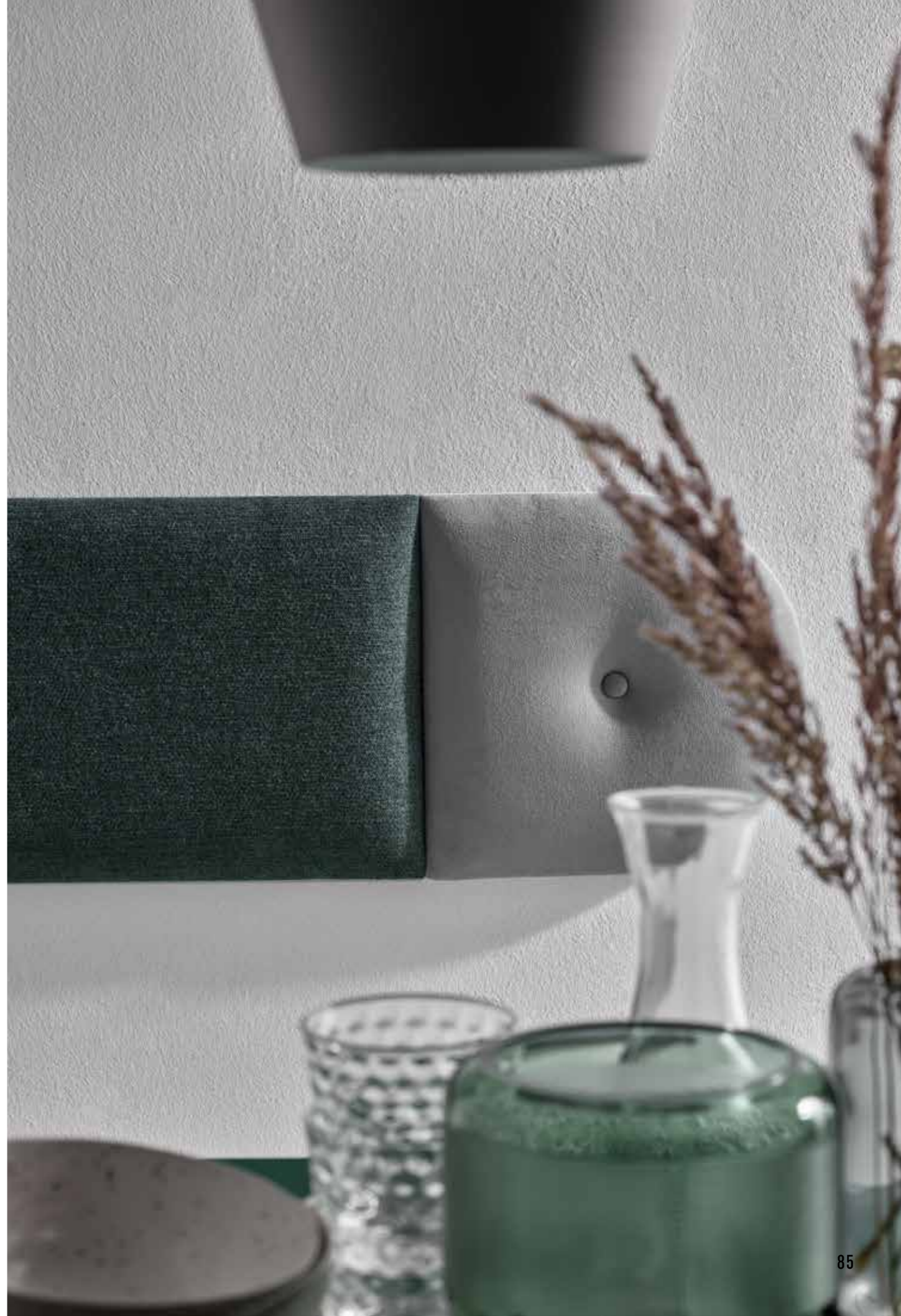

SMALL MOMO SET
GREEN AND GREY

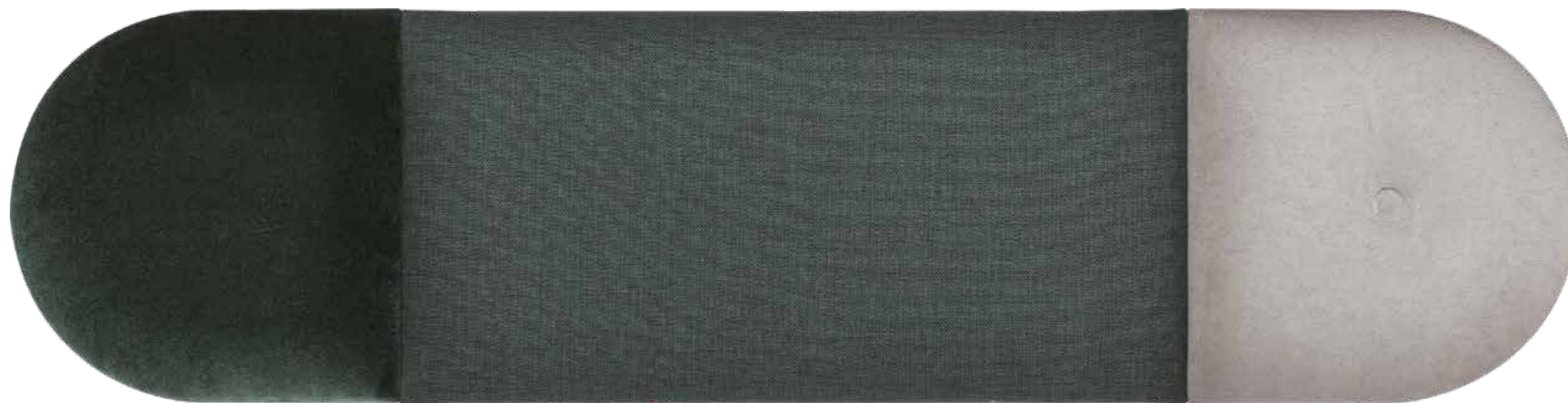

ELEMENTS

- OVAL 2 | Bottle Green Velvet Shiny 1 pc.
- REGULAR 2 | Green Melange 1 pc.
- OVAL 3 | Grey Velvet Matt 1 pc.





**MEDIUM-SIZE MOMO SET
GREEN AND GREY**



ELEMENTS

- REGULAR 2 | Grey Velvet Matt 1 pc.
- REGULAR 3 | Green Melange 1 pc.
- REGULAR 1 | Beige Tweed 1 pc.
- OVAL 3 | Bottle Green Velvet Shiny 2 pcs.

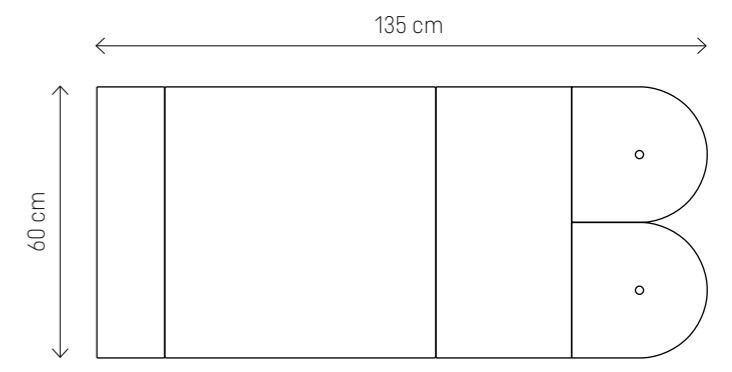

LARGE MOMO SET OVAL
GREEN AND GREY

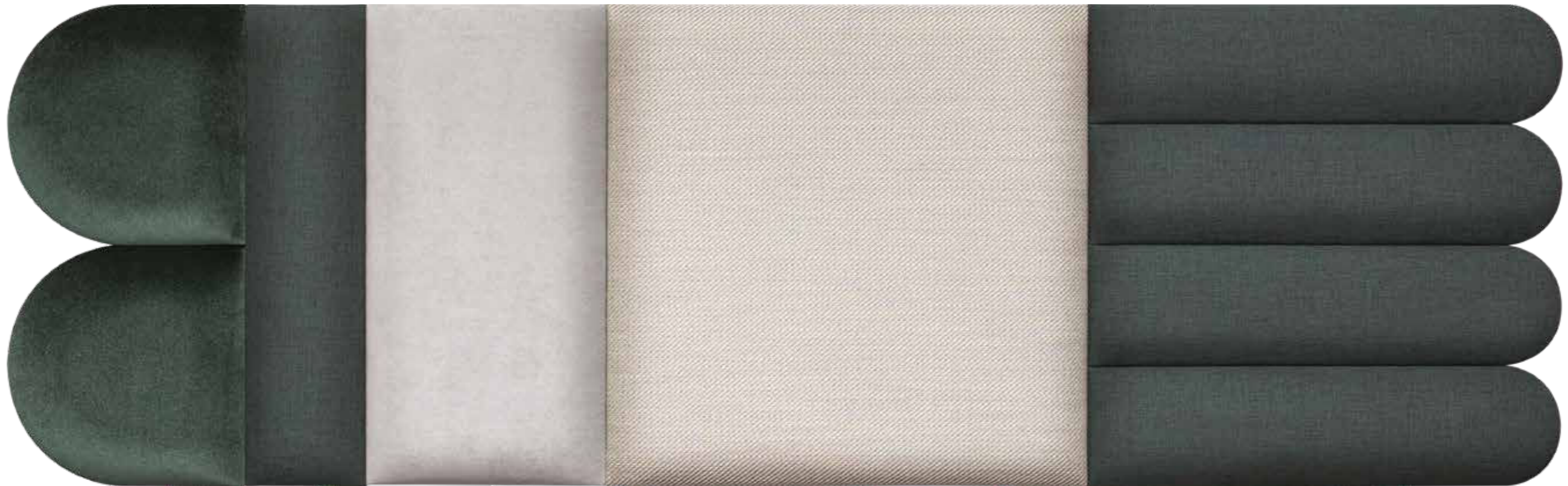

ELEMENTS

- OVAL 2 | Bottle Green Velvet Shiny 2 pcs.
- REGULAR 2 | Green Melange 1 pc.
- REGULAR 1 | Grey Velvet Matt 1 pc.
- REGULAR 3 | Beige Tweed 1 pc.
- OVAL 1 | Green Melange 4 pcs.

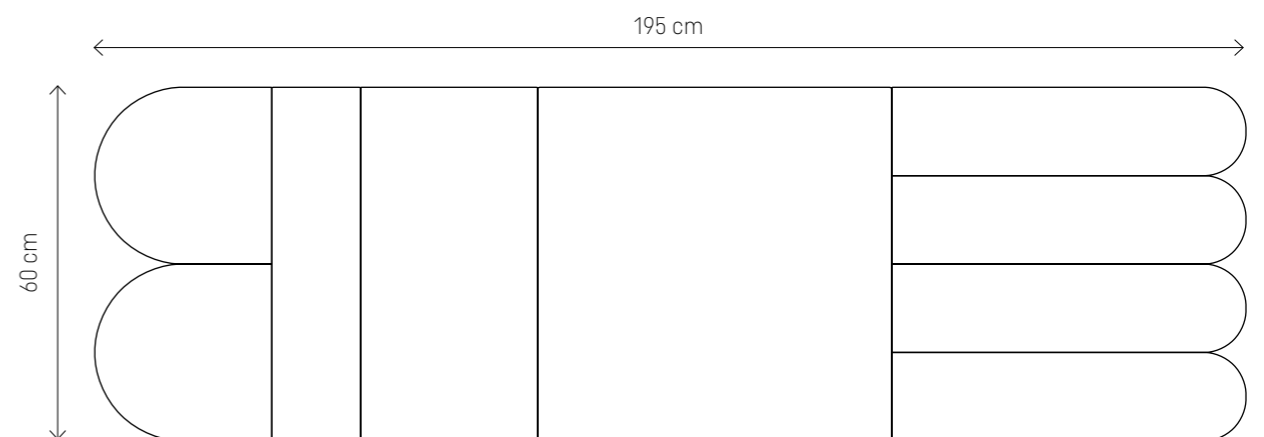

LARGE MOMO SET REGULAR GREEN AND GREY



ELEMENTS

- REGULAR 1 | Grey Velvet Matt 1 pc.
- REGULAR 2 | Bottle Green Velvet Shiny 1 pc.
- REGULAR 3 | Green Melange 1 pc.
- REGULAR 1 | Beige Tweed 1 pc.
- REGULAR 2 | Grey Velvet Matt 1 pc.
- REGULAR 1 | Green Melange 1 pc.

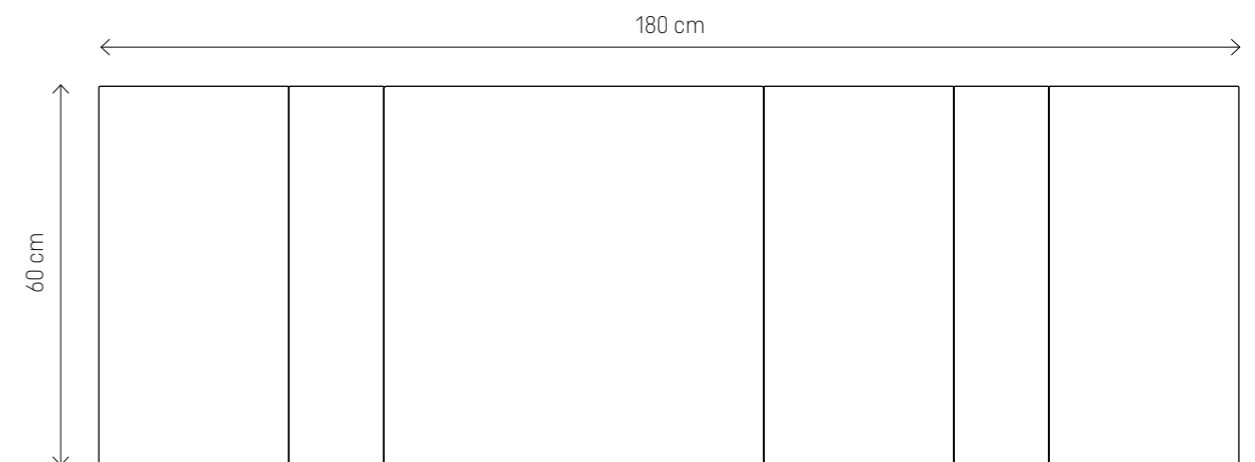



Let your interior become the stage for your creativity. The set of rectangular Regular panels will ensure your comfort while reading in the evening or enjoying your passion for music. Two quilted Oval panels put together constitute a perfect base for photographs and notes. If you wish to create a comfy office space you can combine Regular and Oval panels over your desk to organize your bits and pieces.

**LARGE MOMO SET REGULAR
NAVY BLUE AND GREY**

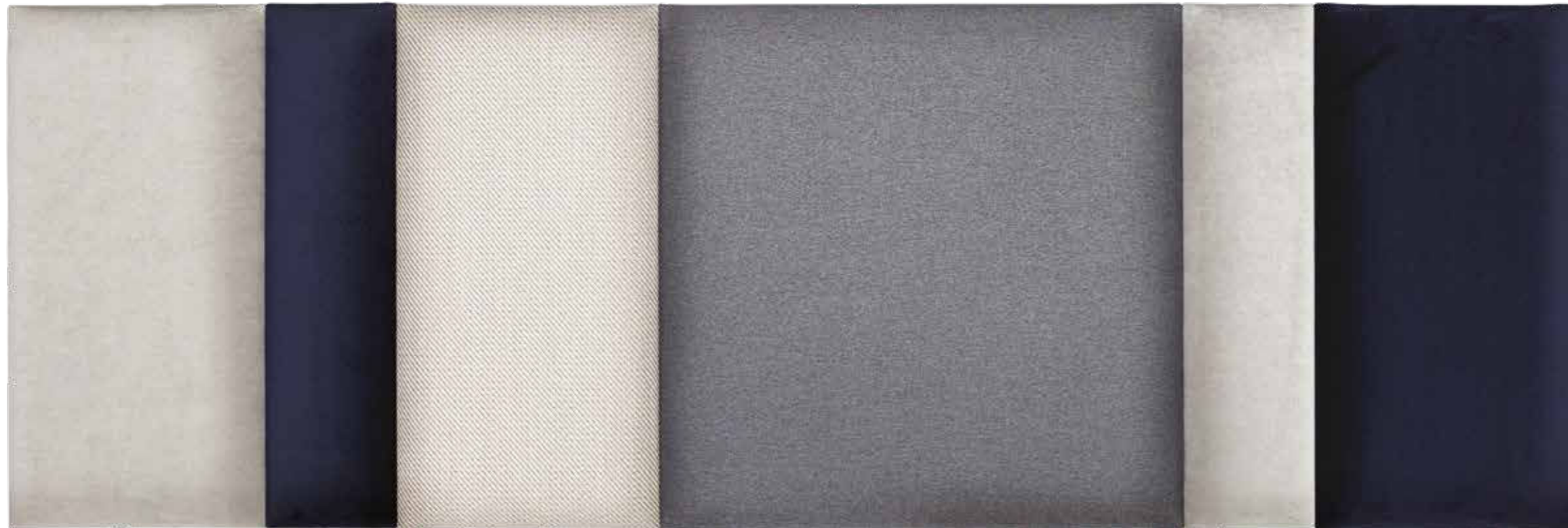

ELEMENTS

- REGULAR 1 | Grey Velvet Matt 1 pc.
- REGULAR 2 | Navy Blue Velvet Shiny 1 pc.
- REGULAR 1 | Beige Tweed 1 pc.
- REGULAR 3 | Graphite Tweed 1 pc.
- REGULAR 2 | Grey Velvet Matt 1 pc.
- REGULAR 1 | Navy Blue Velvet Shiny 1 pc.

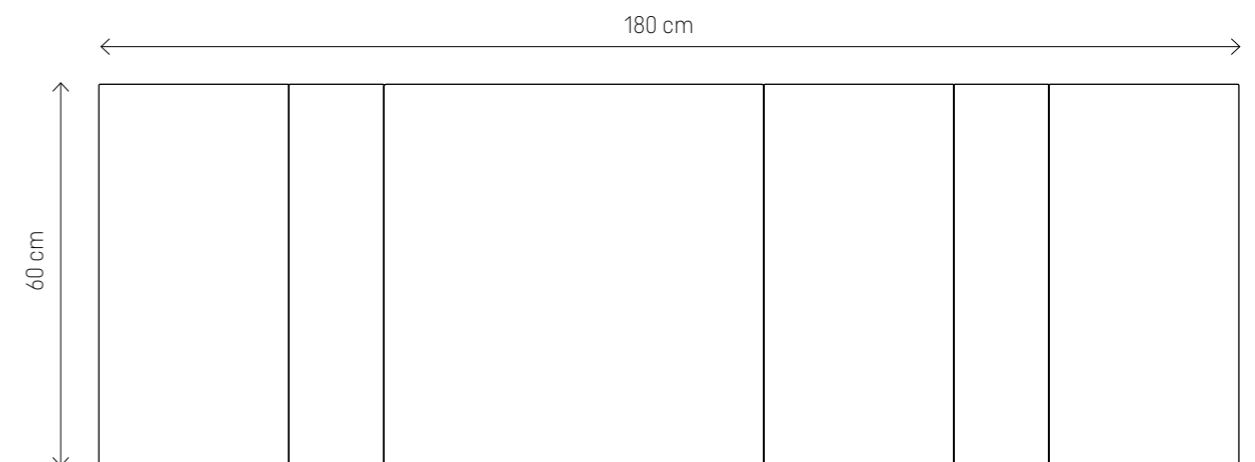

LARGE MOMO SET OVAL
NAVY BLUE AND GREY



ELEMENTS

- OVAL 2 | Grey Velvet Matt 2 pcs.
- REGULAR 2 | Navy Blue Velvet Shiny 1 pc.
- REGULAR 1 | Beige Tweed 1 pc.
- REGULAR 3 | Graphite Tweed 1 pc.
- OVAL 1 | Navy Blue Velvet Shiny 4 pcs.

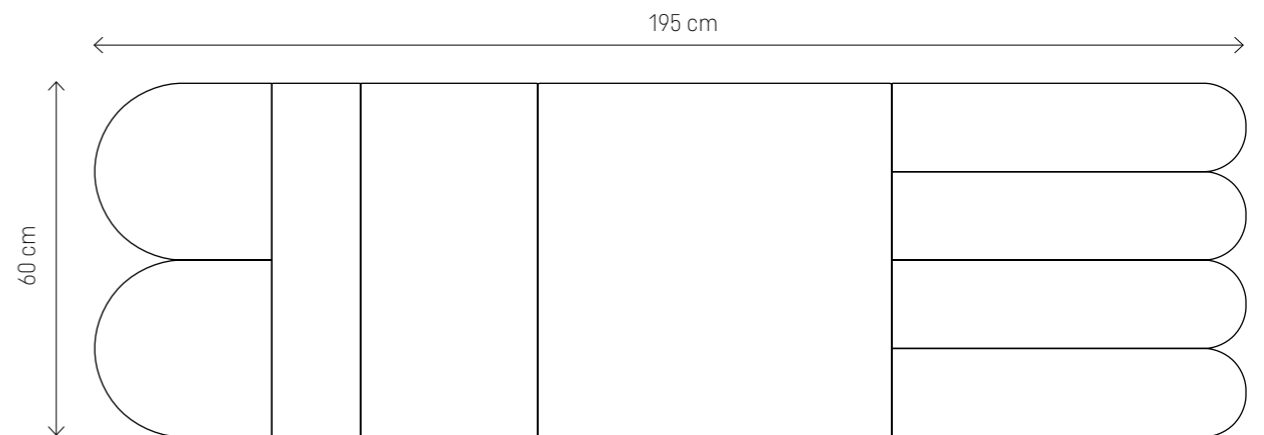

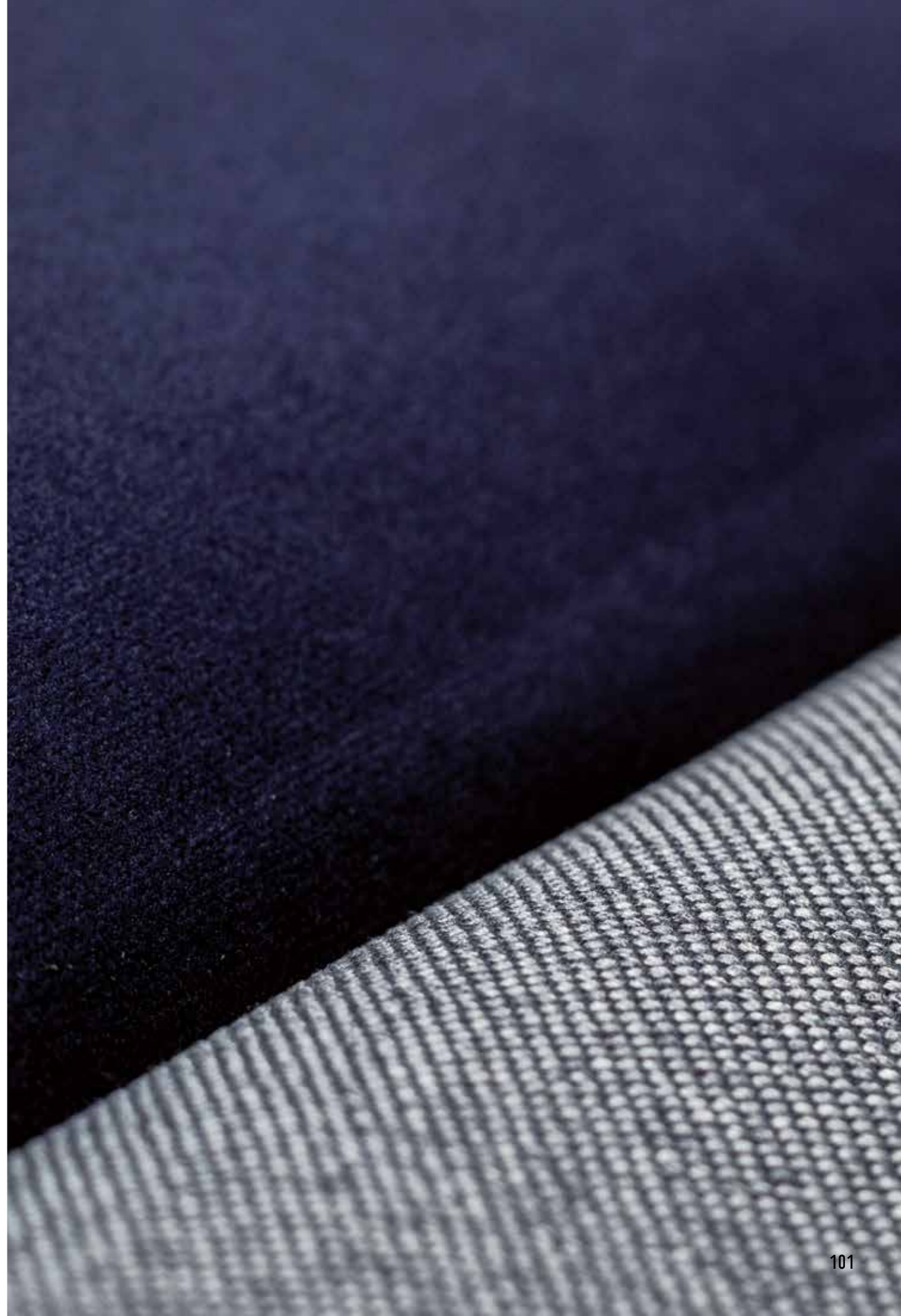

SMALL MOMO SET
NAVY BLUE AND GREY



ELEMENTS

- OVAL 2 | Beige Tweed 1 pc.
- REGULAR 2 | Graphite Tweed 1 pc.
- OVAL 3 | Navy Blue Velvet Shiny 1 pc.





**MEDIUM-SIZE MOMO SET
NAVY BLUE AND GREY**



ELEMENTS

- REGULAR 2 | Beige Tweed 1 pc.
- REGULAR 3 | Graphite Tweed 1 pc.
- REGULAR 1 | Grey Velvet Matt 1 pc.
- OVAL 3 | Navy Blue Velvet Shiny 2 pcs.

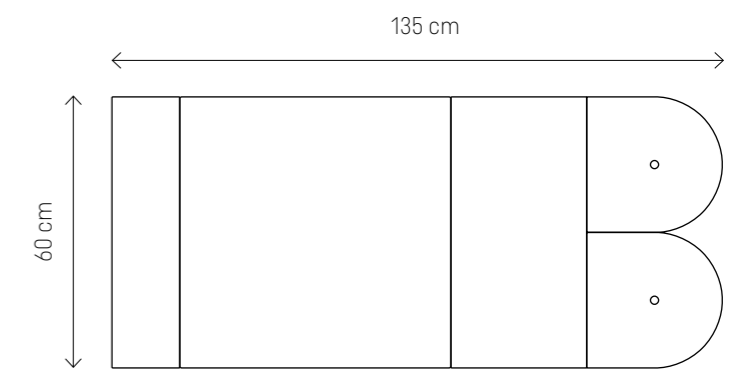

MINI MOMO SET
NAVY BLUE AND GREY



ELEMENTS

- OVAL 3 | Beige Tweed 1 pc.
- OVAL 3 | Navy Blue Velvet Shiny 1 pc.

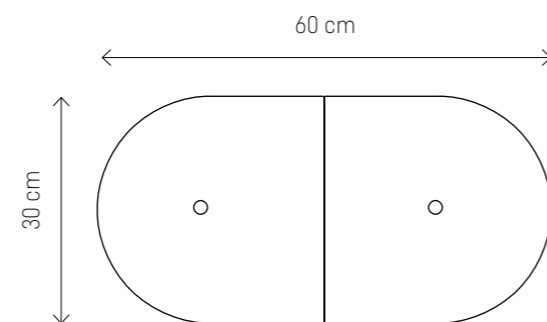

GREY AND PINK

LARGE OVAL SET



OVAL 2 | REGULAR 2 | REGULAR 1 | REGULAR 3 | OVAL 1

195x60 cm

LARGE REGULAR SET



REGULAR 1 | REGULAR 2 | REGULAR 3 | REGULAR 1 | REGULAR 2 | REGULAR 1

180x60 cm

MEDIUM-SIZE SET



REGULAR 2
REGULAR 3
REGULAR 1
OVAL 2

60x135 cm

SMALL SET



OVAL 2
REGULAR 1
OVAL 2

30x120 cm

MINI SET



OVAL 3
OVAL 3

30x60 cm

GREEN AND GREY

LARGE OVAL SET



OVAL 2 | REGULAR 2 | REGULAR 1 | REGULAR 3 | OVAL 1

195x60 cm

LARGE REGULAR SET



REGULAR 1 | REGULAR 2 | REGULAR 3 | REGULAR 1 | REGULAR 2 | REGULAR 1

180x60 cm

MEDIUM-SIZE SET



REGULAR 2
REGULAR 3
REGULAR 1
OVAL 2

60x135 cm

SMALL SET



OVAL 2
REGULAR 1
OVAL 2

30x120 cm

MINI SET



OVAL 3
OVAL 3

30x60 cm

GREY AND MUSTARD

LARGE OVAL SET



OVAL 2 | REGULAR 2 | REGULAR 1 | REGULAR 3 | OVAL 1

195x60 cm

LARGE REGULAR SET



REGULAR 1 | REGULAR 2 | REGULAR 3 | REGULAR 1 | REGULAR 2 | REGULAR 1

180x60 cm

MEDIUM-SIZE SET



REGULAR 2
REGULAR 3
REGULAR 1
OVAL 2

60x135 cm

SMALL SET



OVAL 2
REGULAR 1
OVAL 2

30x120 cm

MINI SET



OVAL 3
OVAL 3

30x60 cm

NAVY BLUE AND GREY

LARGE OVAL SET



OVAL 2 | REGULAR 2 | REGULAR 1 | REGULAR 3 | OVAL 1

195x60 cm

LARGE REGULAR SET



REGULAR 1 | REGULAR 2 | REGULAR 3 | REGULAR 1 | REGULAR 2 | REGULAR 1

180x60 cm

MEDIUM-SIZE SET



REGULAR 2
REGULAR 3
REGULAR 1
OVAL 2

60x135 cm

SMALL SET



OVAL 2
REGULAR 1
OVAL 2

30x120 cm

MINI SET



OVAL 3
OVAL 3

30x60 cm

SELF-ASSEMBLY READY IN FEW MINUTES

MOMO upholstered panels are installed quickly, non-invasively and clean. Pick the fragment of the wall, draw support lines, add some glue to the panel and press it against the wall. Velcro tape can be used instead of glue. Place the tape on the back of the panel, take off the protection film and place the panel against the previously drawn lines.

Clean the wall. Place the arrangement on the floor. Draw a horizontal and a vertical line.

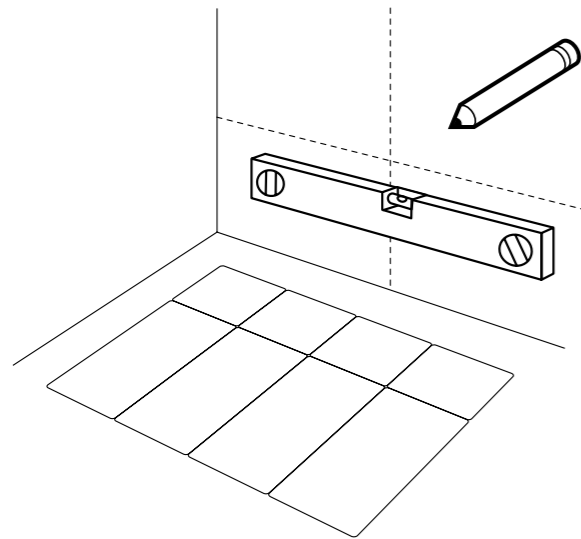

Add glue or place Velcro tape to the panel.

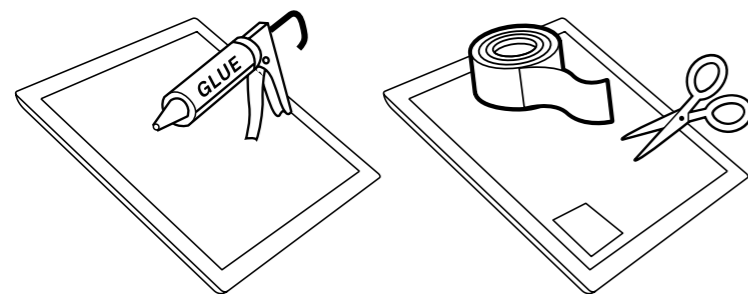

Glue according to the drawing, pressing the panels against the surface. You have limited time to correct the arrangement.

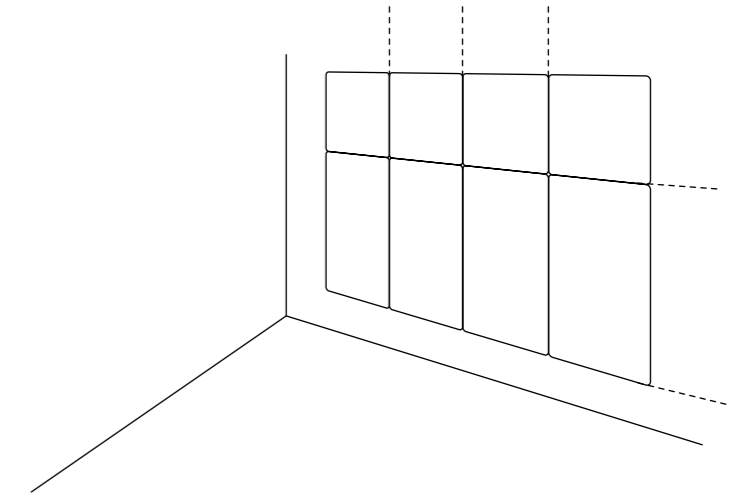

Place the elastic bands on the chosen panels before you glue the panels to the wall.

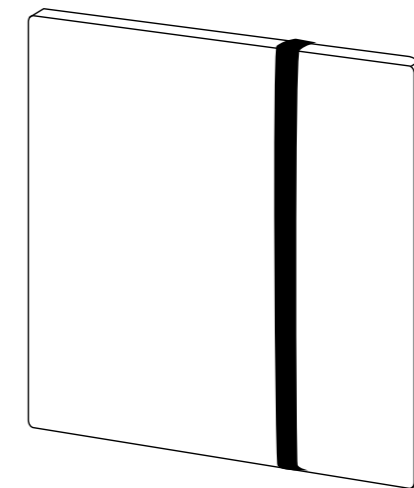

Mount the hooks between the panels before assembly.

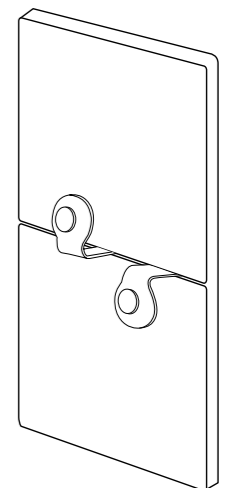

Detailed manual can be found inside the package and on our website.



MOMO WALLS
Wallset Poland
Oginskiego 2,
85-092 Bydgoszcz
Poland

momowalls.com

UPHOLSTERED WALL PANELS



Upholstered panels | Wandpolster Paneele |
Panouri tapițate |
Minkšti skydai | Čalouněné panely | Čalúnené
panely | Paneles tapizados

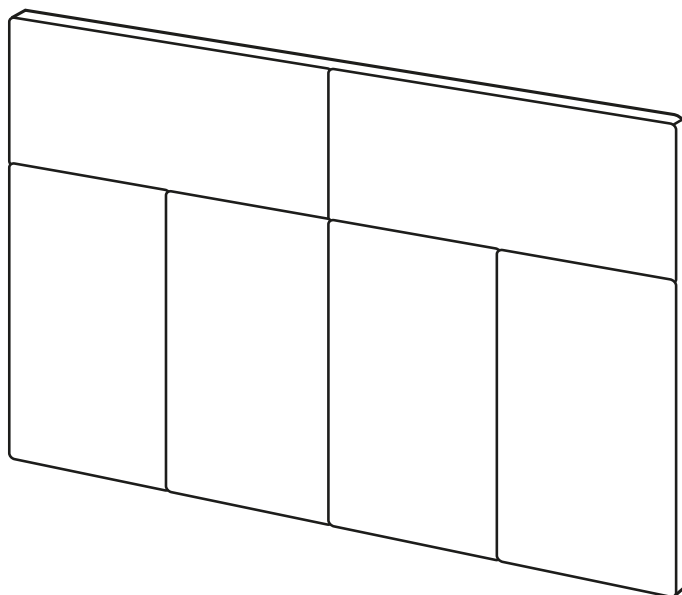

PL | INFORMACJE OGÓLNE

- Należy stosować się do wszystkich zasad wskazanych w instrukcji montażu i użytkowania dostępnej na stronie internetowej momowalls.com
- Nie montować paneli na ścianie pokrytej tapetą. Ściana powinna być gładka i niesypiąca się.
- Czyszczenie tylko przy użyciu łagodnych środków do pielęgnacji tapicerki. Nie prac na mokro. Nie prasować. Nie wybielać.

EN | GENERAL INFORMATION

- Follow all the rules specified in the installation instructions and use the manual available at momowalls.com
- Do not install panels on walls covered with wallpaper. The wall should be smooth, with no peeling surfaces.
- Clean only with mild upholstery care products. Do not wet clean. Do not iron. Do not bleach.

DE | ALLGEMEINE INFORMATIONEN

- Alle Regeln, die in den unter momowalls.com verfügbaren Installations- und Gebrauchsanweisungen angegeben sind, müssen eingehalten werden.
- Installieren Sie die Paneele nicht direkt auf eine Wand mit einer Tapete. Die Wand sollte glatt und tragfähig sein.
- Falls Reinigung, nur mit milden Polsterpflegemitteln. Nicht waschen. Nicht bügeln. Nicht bleichen.

RO | INFORMAȚII GENERALE

- Respectați toate regulile indicate în instrucțiunile de montaj și utilizare, disponibile pe site-ul momowalls.com
- Nu montați panourile pe un perete acoperit cu tapet. Peretele trebuie să fie neted și fără porțiuni exfoliate.
- Curățați zona numai cu produse dedicate de îngrijire a tapietăriei. Nu spălați în mediu umed. Nu clătiți. Nu albiți.

LT | BENDROJI INFORMACIJA

- Laikykites visų taisyklių, nurodytų montavimo ir naudojimo instrukcijoje, kurią rasite interneto svetainėje vox.pl
- Plokščių negalima montuoti ant sienos, padengtos tapetais. Siena turi būti lygi ir tvirta.
- Valyti galima tik švelniais apmušalų priežiūros priemonėmis. Neplauti šlapiu būdu. Nelyginti lygintuvu. Nebalinti.

CZ | VŠEOBECNÉ INFORMACE

- Dodržujte všechna pravidla uvedená v montážním a uživatelském návodě dostupném na internetových stránkách vox.pl
- Panely nemontujte na stěnách potažených tapetami. Stěna musí být hladká a nesmí se drodit.
- Čistěte pouze jemnými prostředky pro péči o čalounění. Nečistěte na mokro. Nežehlit. Nebělit.

SK | VŠEOBECNÉ INFORMÁCIE

- Dodržiavajte všetky pravidlá uvedené v montážnom a užívateľskom návode dostupnom na internetových stránkach vox.pl
- Panely nemontujte na stenách potiahnutých tapetami. Stena musí byť hladká a nesmie sa drobiť.
- Čistite iba jemnými prostriedkami na starostlivosť o čalúnenie. Nečistite mokrou cestou. Nežehliť. Nebieliť.

ES | INFORMACIÓN GENERAL

- Siga todas las reglas especificadas en las instrucciones de instalación y use el manual disponible en vox.pl
- No instale paneles en paredes cubiertas con papel pintado. La pared debe ser lisa, sin superficies descascaradas.
- Limpie solo con productos suaves para el cuidado de la tapicería. No limpiar en húmedo. No planchar. No usa blanqueador.

Installation with glue

Installation with glue | Klebemontage | Montaj cu adeziv | Montavimas su klijais |
Montáž na lepidlo | Montáž na lepidlo | Instalación con cola

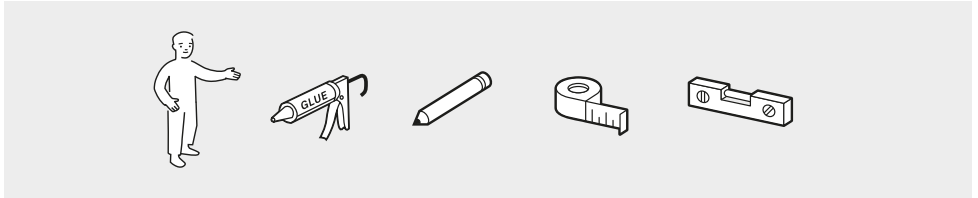

PL Oczyszć ścianę. | EN Clean the wall. | DE Die Wand reinigen. | RO Curățați peretele. | LT Išvalykite sieną. | CZ Očistěte stěnu. | SK Očistite stenu. | ES Limpiar la pared.

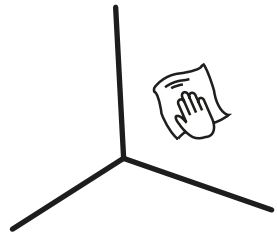

PL Ułóż schemat na podłodze. | EN Place the arrangement on the floor prior to installation. | DE Legen Sie vorab das Schema auf den Boden. | RO Așezați schema pe podea. | LT Padėkite schemą ant grindų. | CZ Položte schéma na podlahu. | SK Položte schému na podlahu. | ES Coloque la disposición en el suelo antes de la instalación.

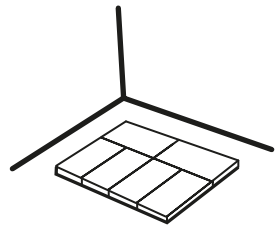

PL Narysuj linię poziomą i pionową. | EN Draw a horizontal and a vertical line on the wall. | DE Zeichnen Sie eine horizontale und eine vertikale Bezugslinie. | RO Trasa i

o linie orizontală și o linie verticală. | LT žymėkite horizontalią ir vertikalią liniją. | CZ Nakreslete vodorovnou a svislou čáru. | SK Nakreslite vodorovnú a zvislú čiaru. | ES Dibuja una línea horizontal y otra vertical en la pared.

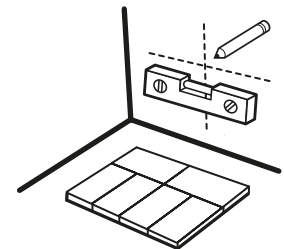

PL Nałóż klej. | **EN** Apply glue. | **DE** Tragen Sie den Kleber auf die Paneele auf. | **RO** Aplica i adezivul. | **LT** Užtepkite klijų. | **CZ** Naneste lepidlo. | **SK** Naneste lepidlo. | **ES** Aplique la cola.

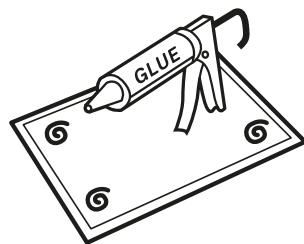

PL Przyklej panel. | **EN** Adhere the panel. | **DE** Kleben Sie die Paneele an die Wand an. | **RO** Lipi i panoul | **LT** Priklijuokite plokštę. | **CZ** Přilepte panel. | **SK** Přilepte panel. | **ES** Encole el panel.

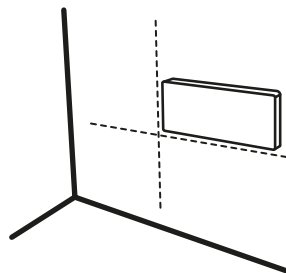

PL Kontynuuj wg schematu dociskając panele. | **EN** Continue in accordance with the arrangement, pressing in the panels. | **DE** Fahren Sie wie gezeigt fort und drücken Sie dabei die Paneele an die Wand an. | **RO** Continua i conform schemei apăsând panourile. | **LT** Tęskite pagal schemą, prispausdami plokštes. | **CZ** Pokračujte dle schématu, přitiskněte panel. | **SK** Pokračujte podľa schémy, pritlačte panel. | **ES** Continuar de acuerdo con la disposición, presionando los paneles.

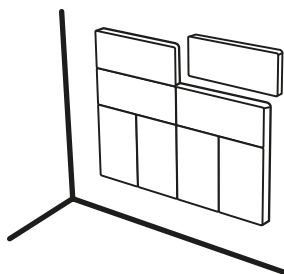

PL Masz ograniczony czas na korektę ułożenia. | **EN** The time to correct the position of the panel is limited. | **DE** Die Zeit, um die Anordnung der Paneele zu korrigieren, ist begrenzt. | **RO** Ave i timp limitat pentru a corecta așezarea. | **LT** Išdėstymą galima koreguoti tik per ribotą laiką. | **CZ** Na úpravu pozice máte omezený čas. | **SK** Na úpravu pozície máte obmedzený čas. | **ES** El tiempo para corregir la posición del panel es limitado.

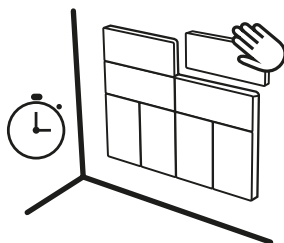

Installation with hook and loop fastener

Installation with hook and loop fastener | Befestigung mittels Klettbandverschluss | Montaj cu încheietoare Velcro | Montavimas su lipniomis juostelėmis | Montáž na suchý zip | Montáž na suchý zips | Instalación con cierre de velcro.

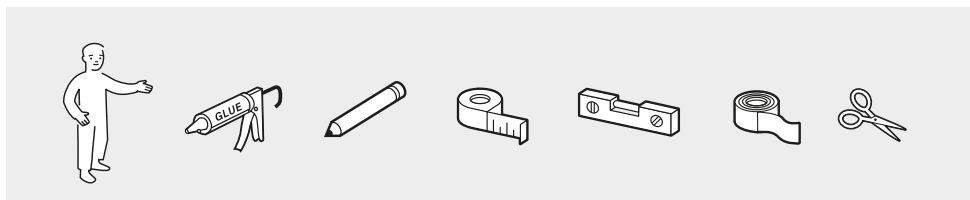

PL Oczyszć ścianę. | EN Clean the wall. | DE Die Wand reinigen. | RO Cură a i peretele. | LT Išvalykite sieną. | CZ Očistěte stěnu | SK Očistite stenu. | ES Limpiar la pared.

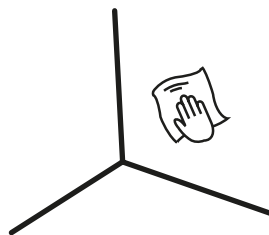

PL Ułóż schemat na podłodze. | EN Place the arrangement on the floor prior to installation. | DE Legen Sie vorab das Schema auf den Boden. | RO Așeza i schema pe podea. | LT Padėkite schemą ant grindų. | CZ Položte schéma na podlahu. | SK Položte schému na podlahu. | ES Coloque la disposición en el suelo antes de la inatación.

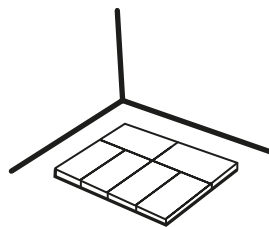

PL Narysuj linię poziomą i pionową. | EN Draw a horizontal and a vertical line on the wall. | DE Zeichnen Sie eine horizontale und eine vertikale Bezugslinie. | RO Trasa i o linie orizontală și o linie verticală. | LT Pažymėkite horizontalią ir vertikaliją liniją. | CZ Nakreslete vodorovnou a svislou čáru. | SK Nakreslite vodorovnú a zvislú čiaru. | ES Dibuje una linea horizontal y otra vertical en la pared.

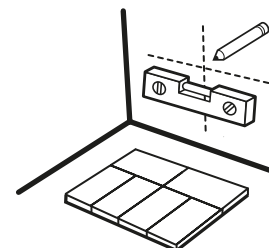

PL Przyklej taśmę rzepową do panelu. | EN Stick the Velcro tape to the panel. | DE Kleben Sie das Klettklebeband auf das Paneel. | RO Lipi i banda Velcro pe panou | LT Priklijuokite lipnią juostą prie skydo. | CZ Nalepte pásku na suchý zip na panel. | SK Nalepte pásku na suchý zip na panel. | ES Pega la cinta de velcro al panel.

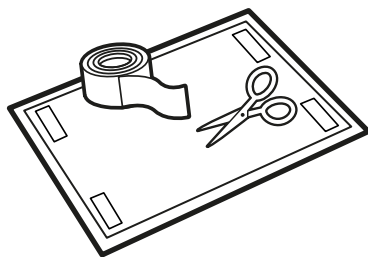

PL Zdejmij folię. | EN Remove the foil. | DE Entfernen Sie die Schutzfolie. | RO Îndepărta i banda. | LT Nuimkite plėvelę. | CZ Odstraňte fólii. | SK Odstráňte fóliu. | ES Retire la lámina.

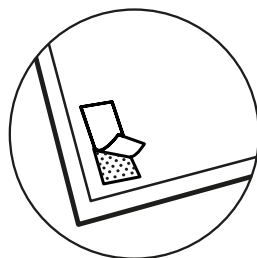

PL Przyklej panel. | EN Adhere the panel. | DE Kleben Sie die Paneele an die Wand an. | RO Lipi i panoul | LT Priklijuokite plokštę. | CZ Přilepte panel. | SK Prilepte panel. | ES Encole el panel.

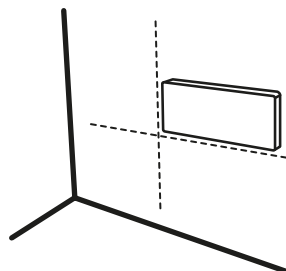

PL Kontynuuj wg schematu dociskając panele. | EN Continue in accordance with the arrangement, pressing in the panels. | DE Fahren Sie wie gezeigt fort und drücken Sie dabei die Paneele an die Wand an. | RO Continua i conform schemei apăsând panourile. | LT Tęskite pagal schemą, prispausdami plokštes. | CZ Pokračujte dle schématu, přitiskněte panel. | SK Pokračujte podľa schémy, pritlačte panel. | ES Continuar de acuerdo con la disposición, presionando los paneles.

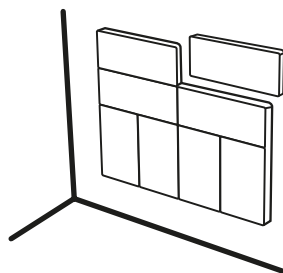

Installation of rubber bands

Installation of rubber bands | Installation von Gummibändern | Montajul benzilor de cauciuc | Guminių juostų montavimas | Instalace gumiček | Instalácia gumičiek | Instalación de bandas de goma

PL Ułóż kompozycję z paneli przed montażem. | EN Place the panels arrangement prior to installation. | DE Legen Sie vorab das Schema auf den Boden. | RO Stabiliți dispunerea panourilor înainte de a începe montajul. | LT Prieš montuodami uždėkite plokščių išdėstymą. | CZ Předem položte schéma panelů na podlahu. | SK Vopred položte schéma panelov na podlahu. | ES Coloque la disposición de los paneles antes de la instalación.

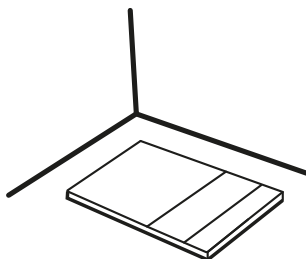

PL Nałóż gumki na wybrane panele. | EN Apply rubber bands on selected panels. | DE Befestigen Sie die Gummibänder an der ausgewählten Paneele. | RO Aplicați benzile de cauciuc pe panourile selectate. | LT Ant pasirinktų plokščių uždėkite gumines juostas. | CZ Připevněte gumičky k vybraným panelům. | SK Pripevnite gumičky k vybraným panelom. | ES Aplique bandas de goma en los paneles seleccionados.

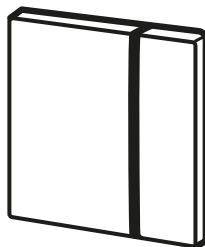

PL Dopasuj położenie gumek w kompozycji paneli. | EN Adjust the arrangement of the rubber bands in the panel composition. | DE Passen Sie die Anordnung der Gummibänder dem gewählten Verlegeschema an. | RO Ajustați poziția benzilor de cauciuc în aranjamentul panourilor. | LT Sureguliuokite guminių juostų išdėstymą skydo kompozicijoje. | CZ Upravte uspořádání gumiček podle zvoleného schématu panelů. | SK Upravte usporiadanie gumičiek podľa zvoleného schémy panelov. | ES Ajuste la disposición de las bandas elásticas en la composición del panel.

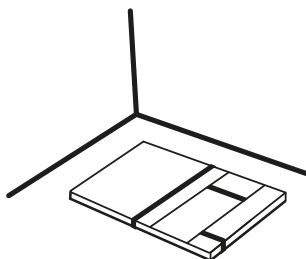

PL Nałóż klej. Pozostaw bez kleju miejsce wokół gumek (około 1-2 cm). Umożliwi to ewentualne drobne poprawki. | **EN** Apply the glue. Leave space without glue around the rubber bands (ca. 1-2 cm). This will enable minor corrections. | **DE** Tragen Sie den Kleber auf. Lassen Sie etwas Platz ohne Kleber um die Gummibänder (ca. 1-2 cm). Dies ermöglicht kleinere Korrekturen. | **RO** Aplicați adezivul. Lăsați o zonă fără adeziv în jurul benzilor de cauciuc (aprox. 1 - 2 cm). Veți putea astfel să realizați mici corecții. |

LT Taikyti klijus. Palikite vietą be klijų aplink gumines juostas (apie 1-2 cm). Tai leis atlikti nedidelius pataisymus. |

CZ Naneste lepidlo. Okolo gumiček (asi 1-2 cm) ponechejte místo bez lepidla. Umožní to drobné opravy. | **SK** Naneste lepidlo. Okolo gumičiek (asi 1-2 cm) ponechajte miesto bez lepidla. Umožní to drobné opravy. | **ES** Aplica la cola. Deje un lugar sin cola alrededor de las bandas de goma (1-2 cm). Esto permitirá correcciones menores.

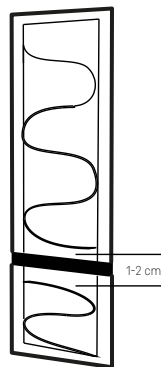

PL Zamontuj panele na ścianę. | **EN** Install the panels on the wall. | **DE** Installieren Sie die Paneele an der Wand. | **RO** Monta i panourile pe perete |

LT Sumontuokite plokštes ant sienos. |

CZ Namontujte panely na zeď. | **SK** Namontujte panely na stenu. | **ES** Instale los paneles en la pared.

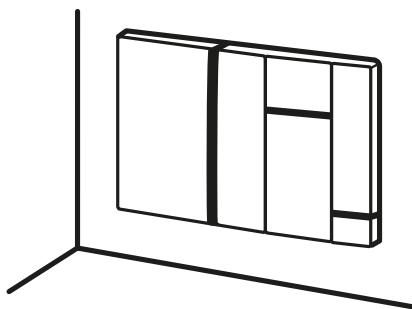

HOOK ASSEMBLY

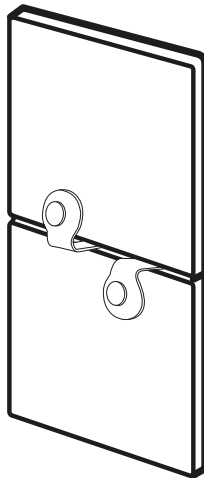
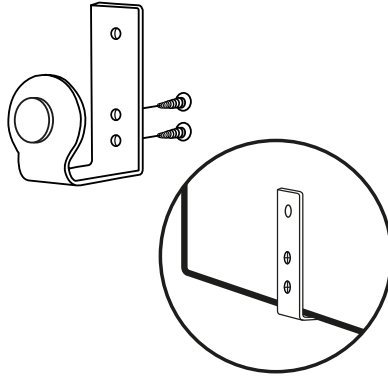

ARRANGEMENT SUGGESTIONS

Arrangement suggestions | Verlegebeispiele | Propuneri de design
| Išdėstymo pasiūlymai | Návrhy uspořádnání | Návrhy usporiadanie |
Sugerencias de arreglos

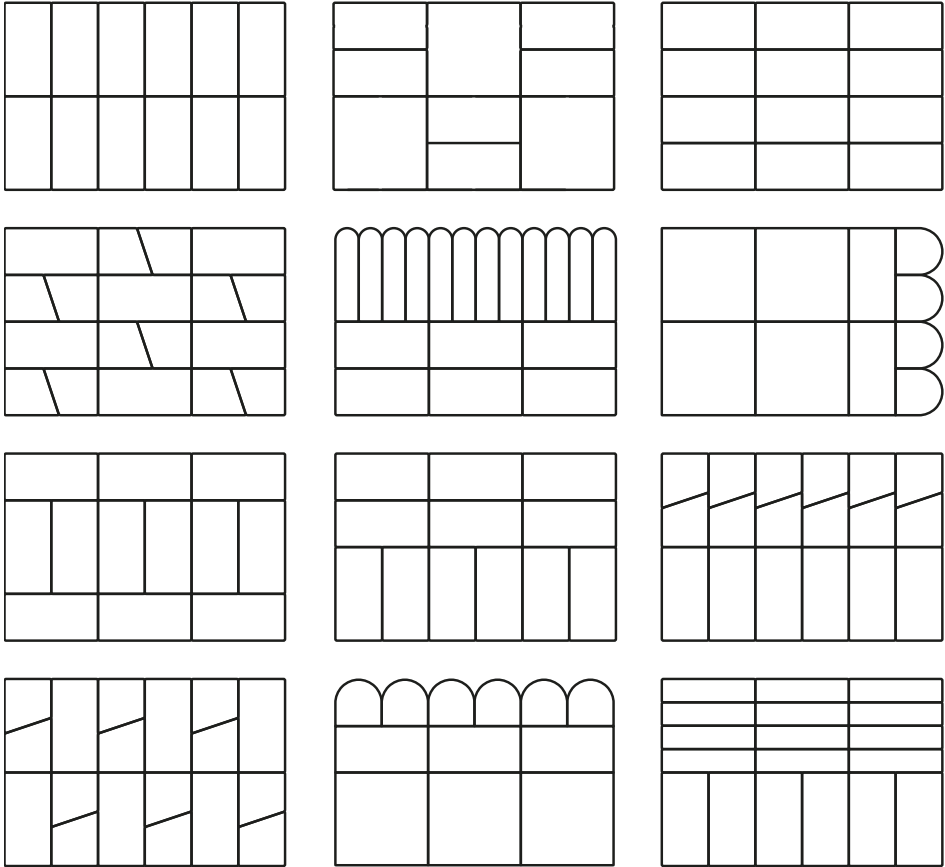



www.momowalls.com

MOMO Panels are manufactured in Poland

MOMO Walls ul.Oginskiego 2, Bydgoszcz Poland
hello@momowalls.com