



Specifications sheet

Your quiet space for undisturbed meetings and deep work



Tuesday booths are built to the highest standards, ensuring the best sound insulation and noise reduction. With Tuesday booths, you can be sure of a peaceful and productive work environment, no matter how noisy your surroundings may be.



✓ Product features



Ventilation

Air flow at 78 m³/hr refreshing air every two minutes.



Sustainability

Recycled materials approx ≥180kg (12m²/0.66m²) each.



Passive Lightning

*4000k (150Lx)
Daylight LED lighting
Dimmable Directional
Strip Task Light.



Magnetic Door System



Electrical

Wall-mounted: UL/CE
220-240v power socket (UK or EU), 2x USB, 1x USB-C.
*Energy Saving Motion Sensor Control.



Work Desk

Designed ergonomically for meetings or working on laptop.



Leading The Sound Pod Industry

Leading the Sound Pod Industry
STC 30 dB & RT0.25s
NIC=25dB
D/C50, 0.76 STI A+



Sofa

Designed ergonomically for meetings or working on laptop.



Product Specifications

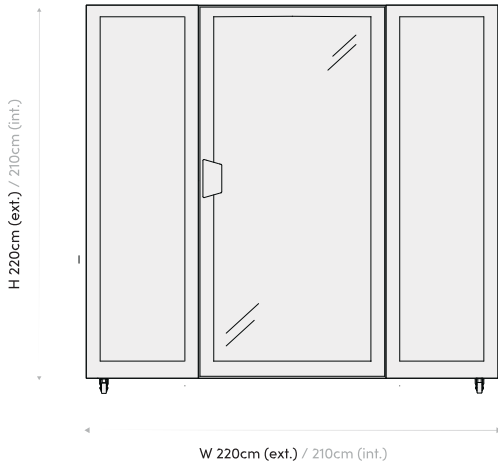

Exterior:
2200w x 1220d x 2200h

Interior:
2100w x 1100d x 2100h

Capacity:
1-4 people

Weight:
459kg (Pod+Furniture)

Power requirements:
Equipped with a directional task lighting bar and singular UL/CE 220-240v power socket (UK or EU) 2x USB, 1x USB-C.

Sound/NIC rating:
Leading the Sound Pod Industry
STC 30 dB & RT0.25s
NIC=25dB
D/C50, 0.76 STI A+

Airflow
78 m3/hr. Refreshing air every two minutes guaranteeing excellent oxygen rates.

Projected area
0.99m²

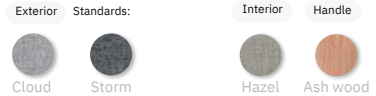

Material

Carbon acoustic plate, PET acoustic plate, Polyester Iacoustic fiber, Aluminum, Stainless steel, ABS plastic.

Safety

Emergency Safety Hammer included for internal fitting.

Fire Rated Foam

UK Fire foam where required.

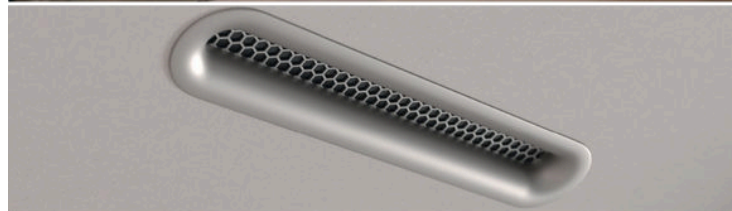

Modern Applications:

Lights, Power, Action! Within the Tuesday booth sits a mini sofa, cushioned for comfort but primarily for support, complimented by an organically curved task desk. Equipped with a directional task lighting bar and singular UL/CE 220-240v power socket (UK or EU) with 2 * USB and 1 * USB-C will power the devices required. The PIR sensor will help save on power, automatically turning o after 5mins of not being occupied.

Sound isolating double walls:

Our booths maintain a $Rw+Ctr$ 30db (+5 db) by utilizing a market leading double walled technology.

Passive Lighting:

Tuesday booth also has non-directional main *4000k (150Lx) Daylight LED lighting, o ering a comfortable, well aired environment.

Air flow technology:

Replacing the air regularly within the Tuesday booth helps the occupant feel fresh and comfortable and surrounds them with fresh oxygen every 2 minutes, promoting health and wellbeing.

Flexible and movable:

Tuesday booth can be moved in minutes; lower the levelling legs allowing the castors to take over and move where ever you want!

Tuesday

LARGE



USER MANUAL

PRODUCT INTRODUCTION

- Net weight: 411kg
- Gross weight: 459kg
- Ventilation: 30-60m³/h



READ BEFORE START

- Dear customer, Thanks for choosing our product, please mind these tips below during the installation:
1. Four people should be prepared for the installation;
 2. Please use cushioning material for stacking parts after unboxing in case of damaging the floor or product;
 3. Please don't scratch any part with a sharp tool;
 4. Please check all listed tools are prepared;
 5. Please check the space for installation is sufficient;
 6. Please follow the step by number to build.

SCAN FOR
ASSEMBLY VIDEO:



GETTUESDAY.CO

PRODUCT SPECS

- External size: W2200*D1230*H2200mm
- Internal size: W2095*D1120*H1960mm
- Projected area: 2.86m²
- Main material:
Carbon plastic, PET, Aluminum, Stainless steel, ABS
- Furniture material:
Birch plywood, Steel, Polyurethane, PET



CIRCUIT DIAGRAM

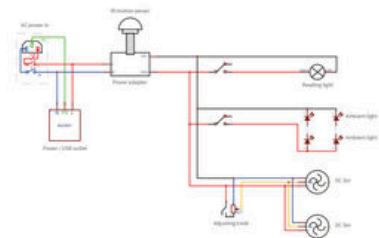











- Input power: 220-230V-50/60Hz
• Output power: 220-230V-50/60Hz, 9A 2.1A
• Maximum power: 2000W

- Ambient light: 3.5W, 2700K, 4000K
• Heating light: 2W, 4000K











PART LIST

- A  Main part
 B  Upholstery
 C  Furniture
 D  Accessory
 E  Tool





Main part

Code	Description	Qty	Preview
A-01	Bottom panel	1	
A-02	Left side panel	1	
A-03	Right side panel	1	
A-04	Top panel	1	
A-05	Front frame (L)	1	
A-06	Glass door	1	
A-07	Front frame (R)	1	
A-08	Rear panel (L)	1	
A-09	Rear panel (M)	1	
A-10	Rear panel (R)	1	





Upholstery

Code	Description	Qty	Preview
B-01	Left wall	1	
B-02	Right wall	1	
B-03	Rear wall (L)	1	
B-04	Middle rear wall (Upper)	1	
B-05	Middle rear wall (Lower)	1	
B-06	Right rear wall	1	
B-07	Ceiling (L)	1	
B-08	Ceiling (M)	1	
B-09	Ceiling (R)	1	
B-10	Carpet	1	















Tool

Code	Description	Qty	Preview
E-01	Perforation socket wrench	1	
E-02	Double head screwdriver	1	
E-03	M6 hex key wrench	1	
E-04	M4 hex key wrench	1	
E-05	M3 hex key wrench	1	

Furniture

Code	Description	Qty	Preview
C-01	Sofa	2	
C-02	Desk	1	
C-03	Bracket	1	
C-04	Desk foot	1	
C-05	Desk leg	1	

Accessory

Code	Description	Qty	Preview
D-01	Caster	40	
D-02	Bolt	45	
D-03	Eccentric wheel	45	
D-04	Level	1	
D-05	Power cable	1	
D-06	Door handles	2	
D-07	Air cushion	1	
D-08	Reading light	1	
D-09	M6x12mm Bolt	40	
D-10	M4x16mm Bolt	12	
D-11	M6x20mm Bolt	7	
D-12	M6x30mm Bolt	3	
D-13	M5x12mm Bolt	2	
D-14	ST4x16mm Bolt	4	
D-15	ST3x25mm Bolt	2	
D-16	81.5x12x8mm Bolt	2	

1



2

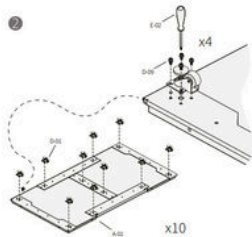

3

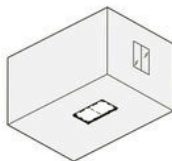

4

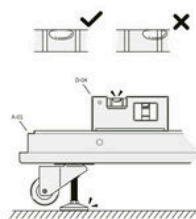

5

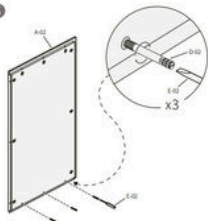

6

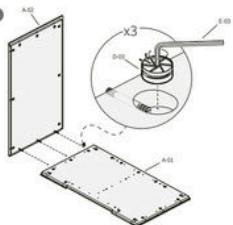

7

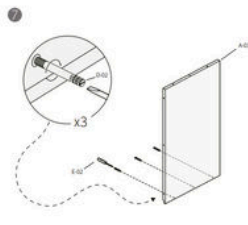

8

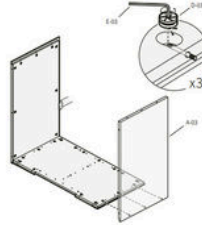

9

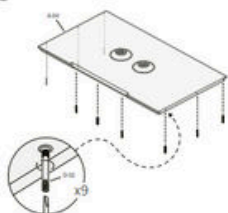

10

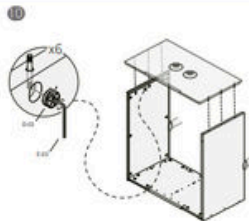

11

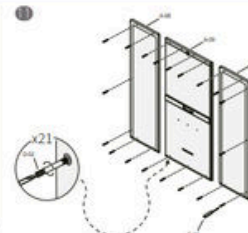

12

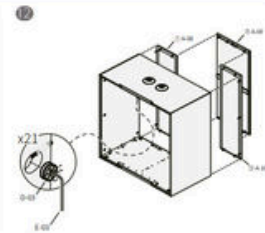

13

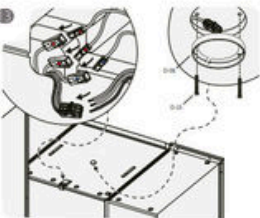

14



15

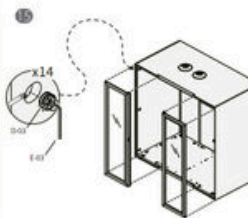

16

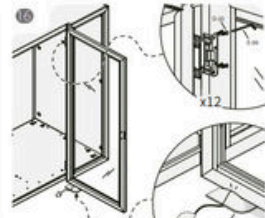

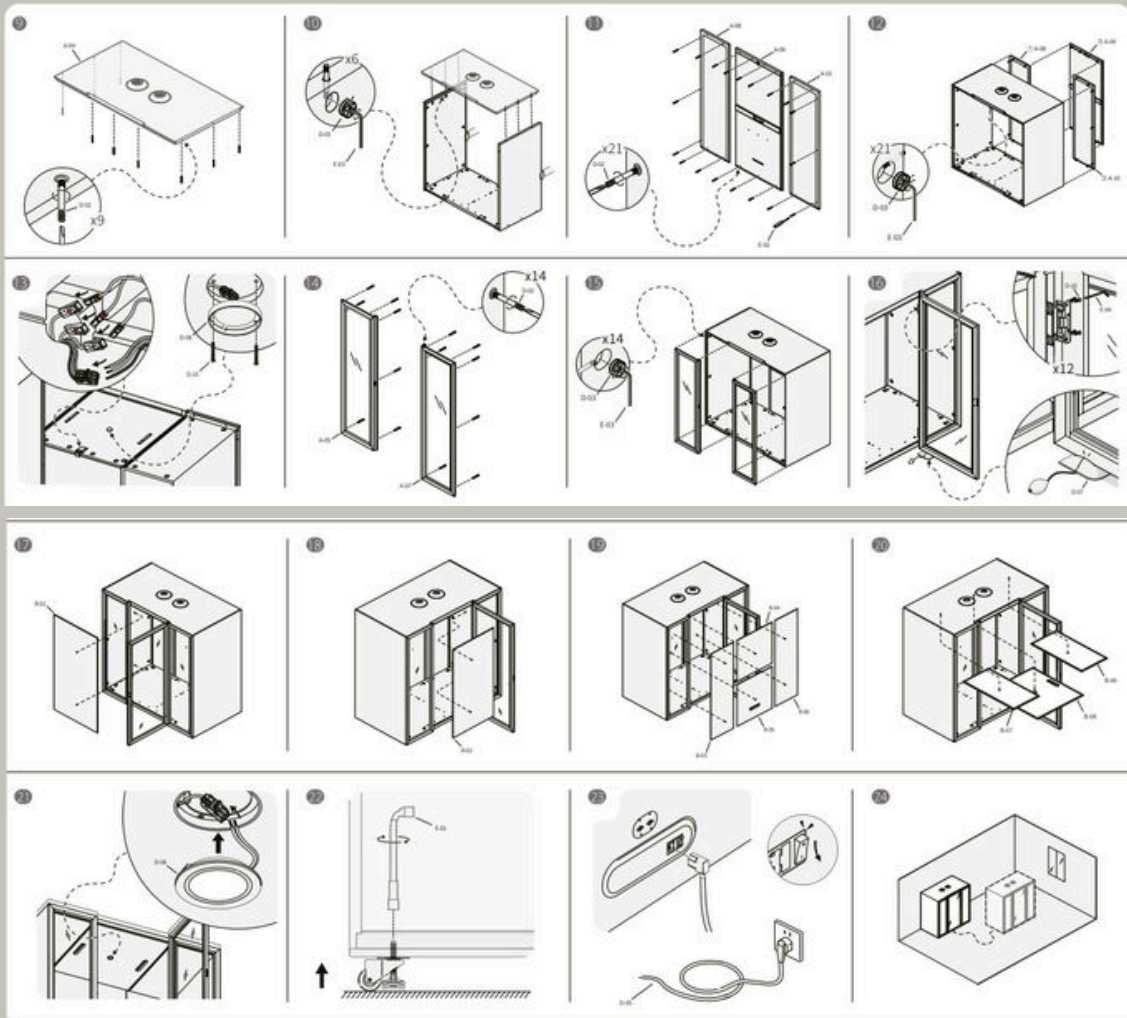

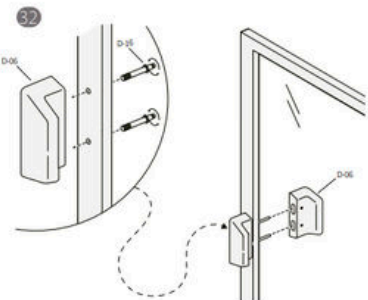
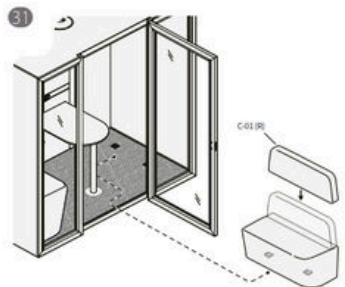
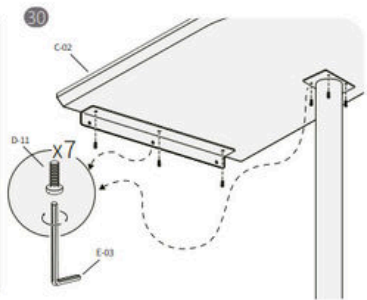
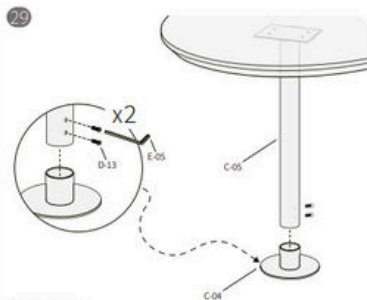
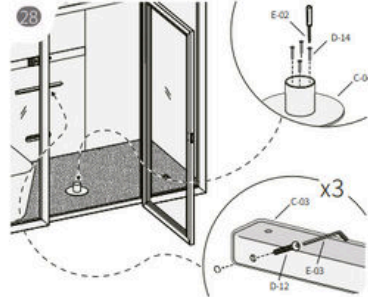
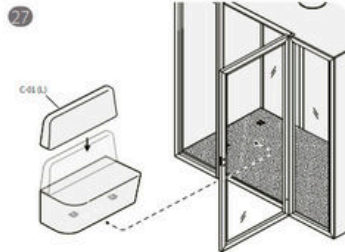
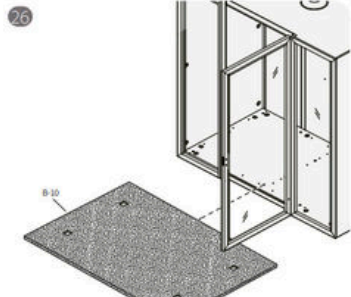
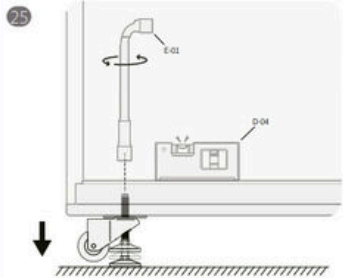

CAUTION

Warning

- ⚠ Do not use any electronics exceeding 1500W in case of overload.
- ⚠ Do not use the product if the ventilation channels are blocked.
- ⚠ Keep the ventilation channels free foreign objects and debris.
- ⚠ Protect all electric hardware from damage that cause electrical leakage.

⚠ Do not modify the original equipment in case of a short circuit.

- ⚠ Do not scratch glass with any sharp object.
- ⚠ Do not smoke or light fires in the pod.
- ⚠ Always set the cable to the non-moving state.
- ⚠ Disconnect the power cord from the power outlet before starting any cleaning, maintenance, or disassembly procedures.

⚠ Do not use the product if the ventilation is not functioning.

- ⚠ Do not climbing on top of the product or place any load on the top of the product.
- ⚠ Do not use this product in an environment with oxygen concentration lower than 23.5%.
- ⚠ Do not slam the door.
- ⚠ Do not use this product outdoors.

Maintenance

- ⚠ Please contact authorized personnel for repairing, don't operate without official instruction.
- ⚠ Do not put anything heavier than 10kg on the desk.
- ⚠ Cut off the power supply if any malfunction occurs.

Problems and Solutions

- In case of no power from the power outlets and the fan or lamp don't work.
 - ⚠ Make sure the power cord is plugged in properly.
 - ⚠ Check if the fuse is burnt out.
 - ⚠ Check that the wire terminal is firmly connected to wire following the correct label.